



 **Accessori per barista**  
Prodotti di qualità per gli specialisti del caffè

 **Barista Tools**  
Quality products for coffee specialists

 **Barista Zubehör**  
Qualitätsprodukte für Kaffeespezialisten

 **Accesorios para barista**  
Productos de calidad para los especialistas del café



**2018**



# The most advanced one-stop shop

for spare parts & accessories, Ho.Re.Ca. and Home appliances

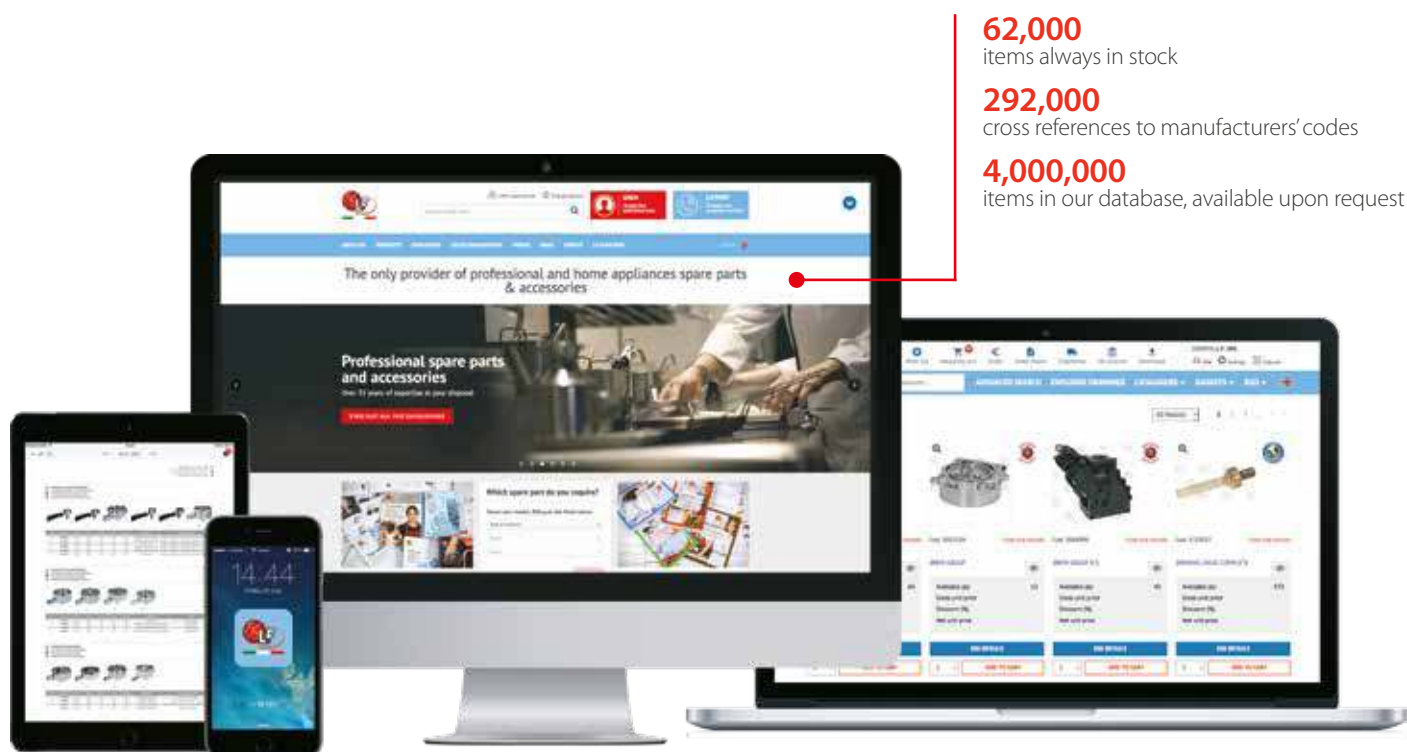

**62,000**

items always in stock

**292,000**

cross references to manufacturers' codes

**4,000,000**

items in our database, available upon request

 **Digital catalogues**  
The whole LF sales program in an instant

 **Exploded drawings**  
More than 200,000 exploded drawings at any time at your disposal

 **Gasket builder**  
Find or create your own gasket

 **Quick search**  
The fastest search engine for spare parts

 **360° picture**  
Discover more than 20,000 items down to the smallest detail

 **News and special offers**  
Keep up-to-date with the latest from LF



[www.lfspareparts724.com](http://www.lfspareparts724.com)

 **Sommario**  
 **Contents**  
 **Inhaltsverzeichnis**  
 **Índice**



 **6** Accessori di complemento  
**12** Attrezzature complete  
**39** Bilance digitali  
**44** Caffettiere  
**46** Cassetti  
**54** Contenitori sottovuoto  
**56** Cucchiaini caffè-cappuccino-latte  
**58** Detergenti  
**80** Docce erogazione gruppo caffè  
**82** Filtri caffè  
**87** Guarnizioni portafiltro  
**88** Kit barista  
**89** Lattiere  
**96** Libri  
**97** Macine  
**99** Manopole portafiltro  
**100** Portafiltri macchine caffè  
**106** Pressini  
**122** Spazzolini  
**125** Strumenti di misura  
**127** Tazzine e bicchieri  
**130** Utensili

 **96** Books  
**122** Brushes  
**82** Coffee filters  
**44** Coffee pots  
**6** Complement accessories  
**127** Cups and glasses  
**58** Detergents  
**39** Digital scales  
**46** Drawers  
**12** Equipment, complete  
**87** Filter holder gaskets  
**99** Filter holder handles  
**100** Filter holders for coffee machines  
**97** Grinders  
**88** Kit for barista  
**125** Measuring tools  
**89** Milk pitchers  
**80** Shower screens for brew group  
**56** Spoons for coffee-cappuccino-milk  
**106** Tampers for coffee  
**130** Tools  
**54** Vacuum food containers

 **80** Auslaufduschen für Kaffeegruppen  
**88** Barista KIT  
**96** Bücher  
**122** Bürsten  
**39** Digitalwaagen  
**82** Kaffeefilter  
**44** Kaffeekannen  
**12** Komplette Ausstattungen  
**56** Löffel für Kaffee-Cappuccino-Milch  
**97** Mahlscheiben  
**125** Messinstrumente  
**89** Milchkannen  
**58** Reinigungsmittel  
**46** Schubladen  
**100** Siebträger für Kaffeemaschinen  
**87** Siebträgerdichtungen  
**99** Siebträgergriffe  
**6** Sonstiges Zubehör  
**106** Tamper  
**127** Tassen & Gläser  
**130** Utensilien  
**54** Vakuumbehälter

 **6** Accesorios y complementos  
**39** Balanzas digitales  
**44** Cafeteras  
**46** Cajones  
**122** Cepillos  
**54** Contenedores al vacío  
**56** Cucharas café-cappuccino-leche  
**58** Detergentes  
**80** Duchas erogación grupo café  
**12** Equipos completos  
**82** Filtros café  
**97** Fresas  
**125** Instrumentos de medida  
**89** Jarras leche  
**87** Juntas portafiltro  
**88** Kit para barista  
**96** Libros  
**99** Mangos portafiltro  
**100** Portafiltras para máquinas café  
**106** Prensas café  
**127** Tazas y vasos  
**130** Utensilios



Baristapro è la linea di articoli pensata da LF per quei baristi costantemente alla ricerca di nuove soluzioni per migliorare il lavoro quotidiano e la qualità del prodotto offerto ai clienti.

La linea comprende filtri, porta filtri e beccucci Baristapro **Nanotech**, significativo esempio della nanotecnologia applicata su parti di macchine da caffè.

Grazie al rivestimento in nanoquarzo le loro superfici sono completamente antiaderenti: pertanto il flusso d'acqua è costante ed uniforme.

Inoltre, se paragonato ad altri prodotti in puro acciaio inox, questo nuovo materiale è molto più resistente all'usura e al calcare.



Baristapro ist eine von LF eingeführte Produktserie für alle Baristas, die ständig nach neuen Lösungen suchen, um ihre tägliche Arbeit zu verbessern und die Produktqualität für ihre Kunden zu erhöhen.

Die Linie Baristapro **Nanotech** umfasst Filter, Siebträger und Düsen, wichtige Beispiele der Nanotechnologie, die auf Ersatzteile von Kaffeemaschinen angewendet werden.

Dank der Nanoquarz-Beschichtung sind ihre Oberflächen antihaftbeschichtet, was einen konstanten und gleichmäßigen Wasserfluss gewährleistet.

Zudem ist dieser neue Werkstoff im Vergleich zu anderen Produkten aus reinem Edelstahl verschleiß- und kalkresistent.



Baristapro is a product series introduced by LF for those baristas who are constantly looking for new solutions to improve their daily work procedures and to increase the product quality being offered to their customers.

The Baristapro **Nanotech** line includes filters, portafilters, nozzles and important examples of nanotechnology being applied to parts of coffee machines.

Thanks to the nanoquartz coat their surfaces are non-stick and this ensures a constant and uniform flow of water.

Moreover, if compared to other products made of pure stainless-steel, this new material is more resistant to wear and limescale.







Baristapro es una serie de productos introducidos por LF para aquellos baristas que buscan constantemente nuevas soluciones para mejorar su trabajo diario y aumentar la calidad de los productos ofrecidos a sus clientes.

La línea **Nanotech** de Baristapro incluye filtros, portafiltros y boquillas, importantes ejemplos de nanotecnología aplicada a piezas de máquinas de café.

Gracias a la capa de nano cuarzo sus superficies son antiadherentes y esto asegura un flujo de agua constante y uniforme.





Además, en comparación con otros productos de acero inoxidable puro, este nuevo material es más resistente al desgaste y a la cal.

-  Filtri caffè
-  Coffee filters
-  Kaffeesiebe für Siebträger
-  Filtros café

**Nanotech**







Vedi pag. / See page / Siehe Seite / Ver pág. **85**

-  Portafiltri macchine caffè e Beccucci di erogazione caffè
-  Filter holders for coffee machines and Coffee spouts
-  Siebträger für Kaffeemaschinen und Kaffee Auslaufdüsen
-  Portafiltros para máquinas café y Bocas salida café

**Nanotech**







Vedi pag. / See page / Siehe Seite / Ver pág. **103**

-  Cassetti
-  Drawers
-  Kaffeesatz-Abklopfkästen
-  Cajones







Vedi pag. / See page / Siehe Seite / Ver pág. **50**

-  Accessori: grembiuli e panni in microfibra
-  Tools: aprons and microfibre cloths
-  Zubehör: Latzschürzen und Mikrofaserlätcher
-  Accesorios: delantales y paños microfibra



Vedi pag. / See page / Siehe Seite / Ver pág. **11-77**

-  Accessori di complemento
-  Complement accessories
-  Sonstige Zubehöre
-  Accesorios y complementos



1494004



1494003







5064220



5064221



1494002

-  Accessori di complemento
-  Complement accessories
-  Sonstige Zubehöre
-  Accesorios y complementos



1494007



5064218



1494005







1494006



5064219



LF Code	Notes	Description
1494004	230x170 mm	TRAY FOR ESPRESSO STAINL. STEEL - VASSOIO INOX
1494003	ø 140x100 mm	CAKE STAND STAINL. STEEL - ALZATINA PASTICCERIA INOX
5064220	ø 113x125 mm	STRAW HOLDER STAINLESS STEEL - PORTACANNUCCE INOX
5064221	ø 90x100 mm	TEA SPOON HOLDER STAINL. STEEL - PORTACUCCHIAINI INOX
1494002	267x96x116 mm	TEASPOON HOLDER 3 PIECES WITH BASE - PORTACUCCHIAINI 3 PEZZI CON BASE
1494007	ø 195x75 mm	SUGAR PACKETS HOLDER STAINL. STEEL - PORTA BUSTINE INOX
5064218	ø 220x78 mm	SUGAR PACKETS HOLDER STAINL. STEEL - PORTA BUSTINE INOX
1494005	180x42 mm	PROFESSIONAL BOTTLE OPENER STAINL. STEEL - APRIBOTTIGLIA INOX
1494006	220 mm	PLIERS FOR SWEETS STAINL. STEEL - MOLLA PER DOLCI INOX
5064219	90x120xh135 mm	NAPKIN HOLDER STAINL. STEEL - PORTATOVAGLIOLI INOX

-  Accessori di complemento
-  Complement accessories
-  Sonstige Zubehöre
-  Accesorios y complementos



1394701



1394702



1394005



1394006



1394007

LF Code	Description
1394701	ALUMINIUM MILK PEN ART - PENNA LATTE ART IN ALLUMINIO
1394702	ALUMINIUM MILK PEN ART KIT - SET PENNE LATTE ART IN ALLUMINIO
1394005	STAINLESS STEEL MILK PEN - PENNA LATTE IN ACCIAIO INOX
1394006	STAINLESS STEEL MILK PEN BLUE GRIP - PENNA LATTE INOX
1394007	STAINLESS STEEL MILK PEN RED GRIP - PENNA LATTE INOX



1080200



5056299







1394009



1394703

LF Code	Description	LF Code	Description
1080200	15/22/30/45/60 ml - 0.5/0.75/1.0/1.5/2.0 oz	1394009	236 ml
5056299	22/30/44/60 ml - 0.75/1.0/1.5/2.0 oz	1394703	30 ml



-  Accessori di complemento
-  Complement accessories
-  Sonstige Zubehöre
-  Accesorios y complementos



1080164



1080165



1080167



1069004



1080166



1094005



LF Code	Description
1080164	SHAKER BOSTON
1080165	GLASS JUG
1080167	COCKTAIL MEASURING BEAKER
1069004	MIXER SPOON
1080166	COCKTAIL STRAINER
1094005	ICE SHOVEL



1094004

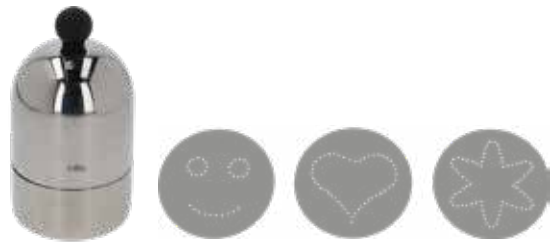





1094905



1094003



LF Code	Description
1094004	STAINLESS STEEL - INOX
1094905	STAINLESS STEEL - INOX
1094003	STAINLESS STEEL - INOX

-  Accessori di complemento
-  Complement accessories
-  Sonstige Zubehöre
-  Accesorios y complementos



1385734



1385778



1385779



1385775



1385780



1385781

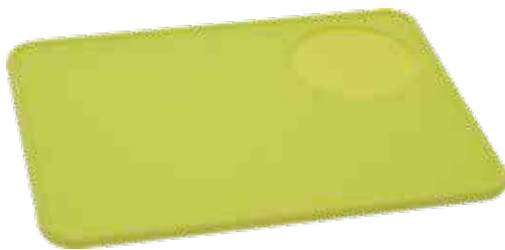

1385782



1385783

LF Code	Description	Dimensions	Material
1385734	BLACK MAT - TAPPETINO APPOGGIO NERO	238x160x48 mm	SILICON RUBBER - GOMMA SILICONICA
1385778	BLACK MAT - TAPPETINO APPOGGIO NERO	200x150x45 mm	SILICON RUBBER - GOMMA SILICONICA
1385779	BLACK MAT - TAPPETINO APPOGGIO NERO	170x140x37 mm	SILICON RUBBER - GOMMA SILICONICA
1385775	BLACK MAT - TAPPETINO APPOGGIO NERO	220x170 mm	SILICON RUBBER - GOMMA SILICONICA
1385780	PINK MAT - TAPPETINO APPOGGIO ROSA	200x150 mm	SILICON RUBBER - GOMMA SILICONICA
1385781	ORANGE MAT - TAPPETINO APPOGGIO ARANCIONE	200x150 mm	SILICON RUBBER - GOMMA SILICONICA
1385782	GREEN MAT - TAPPETINO APPOGGIO VERDE	200x150 mm	SILICON RUBBER - GOMMA SILICONICA
1385783	BLUE MAT - TAPPETINO APPOGGIO AZZURRO	200x150 mm	SILICON RUBBER - GOMMA SILICONICA

## 3494006



**GREMBIULE ROSSO  
VINACCIA BARISTAPRO**

Grembiule da barista in stoffa con  
 pettorina  
 8 tasche  
 cintura in pelle regolabile e sganciabile  
 Larghezza base 58 cm  
 altezza 82 cm

**APRON RED WINE  
BARISTAPRO**

Barista apron with bib made of cloth  
 8 pockets  
 adjustable and removable leather  
 belt  
 Width to base 58 cm  
 height 82 cm

**LATZSCHÜRZE WEINROT  
BARISTAPRO**

Barista Schürze aus Stoff mit Latz  
 8 taschen  
 Verstellbarer und abnehmbarer  
 Ledergürtel  
 Breite zur Basis 58 cm  
 Höhe 82 cm

**DELANTAL ROJO VINO  
BARISTAPRO**

Delantal barista con babero de tela  
 8 bolsillos  
 Cinturón de cuero ajustable y  
 extraíble  
 Ancho hasta la base 58 cm  
 altura 82 cm

## 3494007

**GREMBIULE BLU JEANS  
BARISTAPRO**

Grembiule da barista in jeans con  
 pettorina  
 8 tasche di cui 6 in pelle  
 cintura in pelle regolabile e sganciabile  
 Larghezza base 58 cm  
 altezza 82 cm

**APRON DENIM  
BARISTAPRO**

Barista apron with bib made of  
 denim  
 8 pockets of which 6 made of leather  
 adjustable and removable leather belt  
 Width to base 58 cm  
 height 82 cm





**LATZSCHÜRZE JEANS  
BLAU BARISTAPRO**

Barista Schürze aus Jeans mit Latz  
 8 Taschen, 6 davon aus Leder  
 Verstellbarer und abnehmbarer  
 Ledergürtel  
 Breite zur Basis 58 cm  
 Höhe 82 cm

**DELANTAL AZUL JEANS  
BARISTAPRO**

Delantal Barista con babero de jeans  
 8 bolsillos de los cuales 6 de cuero  
 Cinturón de cuero ajustable y  
 extraíble  
 Ancho hasta la base 58 cm  
 altura 82 cm



-  Attrezzature complete
-  Equipment, complete
-  Kompletogeräte
-  Equipos completos

## Montalatte

Milk frothers  
Milchschaumer  
Espumadoras de leche



1235140



LF Code	Capacity	Dimensions
1235140	330 ml	103x220 mm



2106311





2106211



1235065





 Creano schiuma di latte in pochi secondi  
coperchio anti schizzi - facili da pulire  
ideali anche per cioccolata calda e fredda  
elemento riscaldante incorporato  
3 funzioni:  
miscelano e schiumano a freddo  
scaldano e miscelano a caldo  
scaldano e montano il latte  
lattiere con rivestimento antiaderente  
lavabili in lavastoviglie

 They froth milk in few seconds  
anti-splash lid - easy to clean  
also ideal for hot and cold chocolate  
built-in heating element  
3 functions:  
froth hot milk  
froth cold milk  
warm up milk  
milkpitchers with non-stick coating  
dishwasher safe

 Sie erzeugen Schaum in wenigen Sekunden  
Spritzschutzdeckel - einfach zu reinigen  
Ideal für heiße und kalte Schokoladen  
Eingebautes Heizelement  
3 Funktionen:  
sie mischen und schäumen kalte Milch  
sie mischen und schäumen heiße Milch  
sie wärmen die Milch beim mischen  
Milchkännchen mit Antihalt-Beschichtung  
spülmaschinenfest

 Crean espuma de leche en cuestión de segundos  
Tapa anti-salpicaduras - fácil de limpiar  
Ideal para chocolate caliente y frío  
Elemento calentador incorporado  
3 funciones:  
Mezclador y generador de espuma en frío  
Calentador y mezclador en caliente  
Calentador y espumadora de leche  
Lecheras con revestimiento antiadherente  
Aptos para lavavajillas

LF Code	Power supply	Capacity	Dimensions
2106311	230V 50Hz 600W	250 ml	122x174x182 mm
2106211	230V 50Hz 600W	250 ml	125x150x170 mm
1235065	230V 50Hz 600W	450 ml	125x180x180 mm

-  **Attrezzature complete**
-  **Equipment, complete**
-  **Komplettgeräte**
-  **Equipos completos**

 **la Pavoni**

**1235200**

 **MACCHINA CAFFÈ EUROPICCOLA LUSO 240V**

alimentazione 220/240V 50/60Hz 950W  
dimensioni:  
larghezza 200 mm  
profondità 290 mm  
altezza 320 mm  
caldaia 0,8L  
pressione in caldaia 0,7/0,8 bar

 **COFFEE MACHINE EUROPICCOLA LUSO 240V**

power supply 220/240V 50/60Hz 950W  
dimensions:  
width 200 mm  
depth 290 mm  
height 320 mm  
boiler 0.8L  
boiler pressure 0.7/0.8 bar

 **KAFFEEMASCHINE EUROPICCOLA LUSO 240V**

Spannung 220/240V 50/60Hz 950W  
Maße:  
Breite 200 mm  
Tiefe 290 mm  
Höhe 320 mm  
Boiler 0,8L  
Boilerdruck 0,7/0,8 bar

 **MÁQUINA CAFÉ EUROPICCOLA LUSO 240V**

alimentación 220/240V 50/60Hz 950W  
medidas:  
anchura 200 mm  
profundidad 290 mm  
altura 320 mm  
calderín 0,8L  
presión calderín 0,7/0,8 bar







 Europiccola, disegnata nel lontano 1950, è un prodotto che riflette uno spaccato della storia italiana del design. È la macchina a leva che non conosce mode. Costruita con materiali pregiati, non teme le incrostazioni di calcare, limitando gli interventi di manutenzione ordinaria. Il modello Europiccola permette di ottenere 8 tazze di caffè espresso consecutivamente.

 Europiccola, deren Design auf das ferne 1950 zurückgeht, ist ein Erzeugnis, der einen Querschnitt durch die italienische Designgeschichte verkörpert. Diese Handhebelmaschine liegt immer im Trend. Zur Konstruktion dieses Gerätes werden hochwertige Materialien verwendet, dadurch wird die Anfälligkeit für Verkalkungen reduziert und eine Langlebigkeit des Gerätes garantiert. Das Modell Europiccola hat eine Boilerkapazität für die Vorbereitung von 8 Espresso-Tassen hintereinander.

 Europiccola, designed back in 1950, is a symbol par excellence of Italian design with its classic, timeless design. Europiccola is mainly made of solid cast brass and it is built to last. Its large boiler ensures that limescale deposits have minimal effect, meaning little to none maintenance. Europiccola delivers up to 8 cups of espresso continuously.

 Europiccola, diseñada en 1950, es un producto que refleja la historia italiana del design. Es la máquina de palanca que no conoce modas. Realizada con materiales de calidad, no teme a la calcificación, limitando las intervenciones de mantenimiento ordinaria. El modelo Europiccola permite obtener 8 tazas de café espresso consecutivamente.

-  **Attrezzature complete**
-  **Equipment, complete**
-  **Komplettgeräte**
-  **Equipos completos**

## 1480100

 **DISSIPATORE  
ELETRICO  
PRO-FONDI**

alimentazione: in 100/240V  
50/60Hz - out 12VCC  
completo di girante da 57 e  
da 53 mm  
completo di anello ferma  
sacchetto  
completo di spazzola per la  
pulizia  
per l'installazione serve un  
foro da 120 mm  
ingombro sottobanco 170  
mm  
per TUTTI I TIPI DI MACCHINE  
CAFFÈ

 **ELEKTRISCHE  
KAFFEESATZBÜRSTE  
PRO-FONDI**

Stromversorgung: in  
100/240V 50/60Hz - out  
12VCC  
komplett mit Laufrad von 57  
und 53 mm  
komplett mit Ring für Tüte  
komplett mit beiden Bürsten  
zur Reinigung  
zur Installation ist ein 120  
mm Loch erforderlich  
Gesamtgröße Untertisch  
170 mm  
für KAFFEEMASCHINEN ALLE  
TYPEN

 **ELECTRICAL  
DISPOSER  
PRO-FONDI**

power supply: in 100/240V  
50/60Hz - out 12VCC  
complete with 57 and 53  
mm impeller  
complete with bag holding  
ring  
complete with brush for  
cleaning  
a 120 mm hole is required for  
the assembly  
dimensions under the  
counter 170 mm  
for ALL KINDS OF COFFEE  
MACHINE

 **LIMPIADOR  
ELÉCTRICO  
PRO-FONDI**

alimentación: in 100/240V  
50/60Hz out 12VCC  
con impulsor 57 y 53 mm  
con anillo cierra bolsito  
con cepillo para limpieza  
p. la instalación necesita  
agujero de 120 mm  
medidas debajo mesa 170  
mm  
para TODO TIPO DE  
MÁQUINA DE CAFÉ



LF Code	Power supply
1480100	in 100/240V 50/60Hz - out 12VCC



1480101



1480102





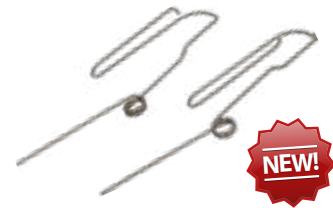

1480103



5065655



LF Code	Notes
1480101	ø 57/58 mm
1480102	ø 53 mm
1480103	ø 53/57/58 mm
5065655	SPRING KIT

-  **Attrezzature complete**
-  **Equipment, complete**
-  **Komplettgeräte**
-  **Equipos completos**

 **Silenzioso - Igienico - Pratico**

Pro-Fondi è un dispositivo elettrico nato per risolvere le problematiche dell'estrazione e della pulizia dai fondi di caffè del portafiltro di macchine da caffè espresso

 **Leise - Schnell - Perfekte Reinigung**

Pro-Fondi ist ein elektrischer Helfer, gebaut, um die üblichen Probleme beim Ausklopfen und Reinigen der Siebträger zu verhindern

 **Noiseless - Quick - Perfect cleaning**

Pro-Fondi is an electrical device designed to solve problems concerning to extraction and the cleaning of coffee grounds off filter holders in espresso coffee machines

 **Silencioso - Higiénico - Práctico**

Pro-Fondi es un dispositivo eléctrico nacido para resolver las problemáticas de la extracción y de la limpieza de los restos del café del portafiltro de máquinas de café espresso

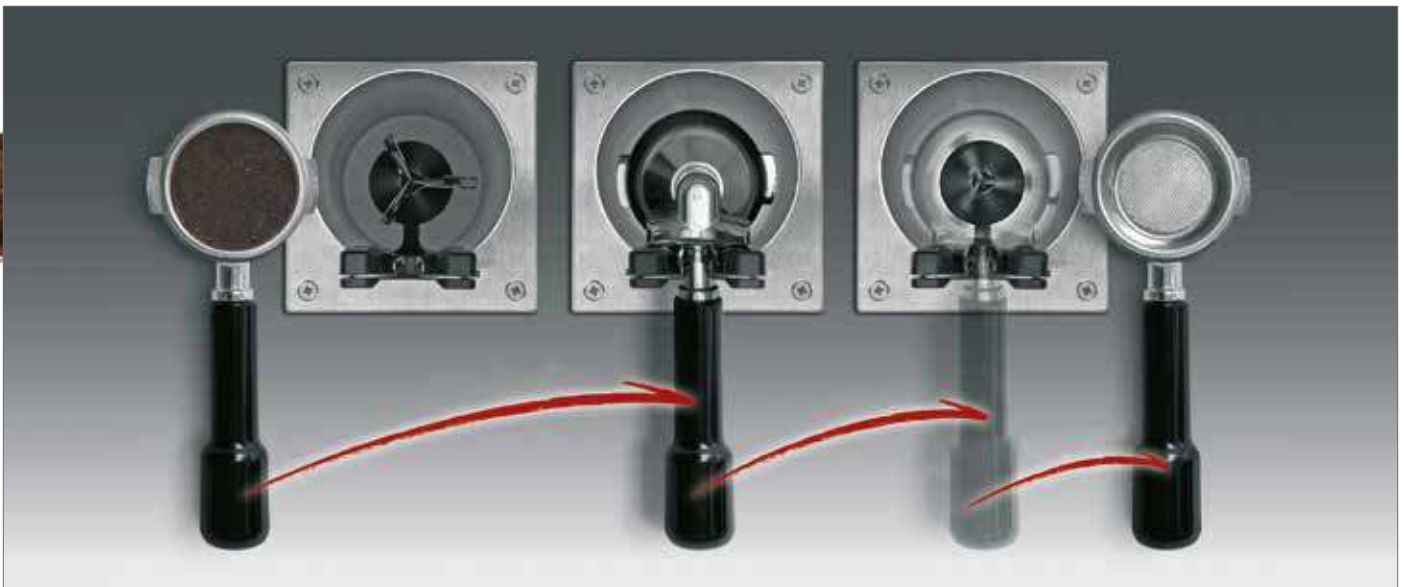
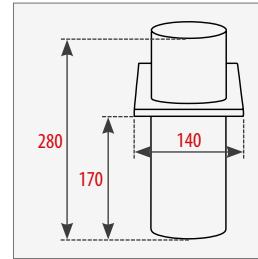
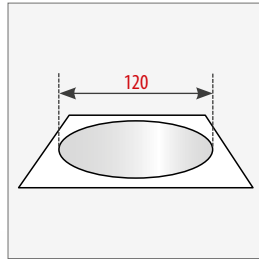





- 
- Ottimizza la pulizia del filtro migliorando il risultato in tazza
  - Evita di sporcare la pedana
  - Evita la battuta del porta filtro migliorando il comfort acustico del vostro locale
  - Evita la sostituzione dei filtri e l'abrasione dei gruppi
  - Più veloce della classica battuta
  - Evita traumi al braccio e alla spalla
  - Raccoglie e smaltisce i fondi in modo igienico
  - Non necessita di pulizie e manutenzioni particolari
  - Evita l'ingombro del vecchio cassetto verso l'operatore
  - Raccoglie grandi quantità di fondi nello stesso sacchetto

- 
- It thoroughly cleans the filter, improving the taste
  - No dirt on the floor
  - No loud noises with subsequent improvement of the acoustic environmental comfort
  - Less filter replacing and less abrasion of the groups
  - Faster filter cleaning
  - Less strain on arms and shoulders
  - Hygienical procedure
  - It does not require special maintenance and cleaning
  - No worry about the knockbox becoming full
  - One single disposal bag can contain large amounts of waste

- 
- Perfekte Reinigung - Geruchlos
  - Kein Schmutz auf dem Fußboden
  - Keine Abschlagkästen, akustischer Komfort für die Gäste
  - Filter müssen seltener getauscht werden
  - Schneller als ausklopfen und ausspülen
  - Nicht körperlich anstrengend
  - Hygienische Abfallentsorgung
  - Benötigt keine besondere Handhabung oder Pflege
  - Keinen Platzmangel durch Abschlagboxen
  - Es sammelt große Mengen Kaffeepulver in der selben Tüte

- 
- Optimiza la limpieza del filtro mejorando el resultado en taza
  - Evita ensuciar la tarima
  - Evita el batido del portafiltro mejorando el confort acústico de su local
  - Evita la sustitución de los filtros y la abrasión de los grupos
  - Más veloz del clásico batido
  - Evita dolores de brazo y espalda
  - Recoge y elimina los restos en modo higiénico
  - No necesita limpieza y mantenimientos particulares
  - Evita la obstrucción del viejo cajón hacia el operador
  - Recoge grandes cantidades de restos en el mismo saco

-  Attrezzature complete
-  Equipment, complete
-  Kompletogeräte
-  Equipos completos



**NEW!**



1600 g

637  
240 315

1235136

**NEW!**



1400 g

593  
232 264

1235135

**NEW!**



250 g

325  
130 200

1235134

**NEW!**



300 g

350  
120 180

1235138

**NEW!**







300 g

350  
120 180

1235137

LF Code	Model	Grinding burrs ø (mm)	Coffee bean capacity (g)	Power supply	Dimensions (mm)
1235136	OLYMPUS 75 A	75	1600	220/240V 900W 50/60Hz	240x315x637
1235135	ZENITH 65 E	65	1400	220/240V 350W 50/60Hz	232x264x593
1235134	MIGNON	50	250	220/240V 260W 50/60Hz	130x200x325
1235138	MIGNON PERFETTO	50	300	220/240V 300W 50/60Hz	120x180x350
1235137	MIGNON SILENZIO	50	300	220/240V 300W 50/60Hz	120x180x350







-  Attrezzature complete
-  Equipment, complete
-  Kompletogeräte
-  Equipos completos

# Fiorenzato







LF Code	Model	Grinding burrs ø (mm)	Coffee bean capacity (g)	Power supply	Dimensions (mm)
1252650	F5 AUTOMATIC - AUTOMATICO	64	1500	220/240V 50Hz 350W	230x270x615
5088894	F6 AUTOMATIC - AUTOMATICO	83	1500	220/240V 50Hz 650W	230x270x615
1252660	F64 ELECTRONIC - ELETTRONICO	64	1500	220/240V 50Hz 350W	230x270x615
1235133	F83 ELECTRONIC - ELETTRONICO	83	1500	220/240V 50Hz 650W	230x270x670
1235132	F4 NANO ELECTRONIC - ELETTRONICO	58	500	220/240V 50Hz 250W	169x240x473

-  Attrezzature complete
-  Equipment, complete
-  Kompletogeräte
-  Equipos completos



LF Code	Model	Grinding burrs ø (mm)	Coffee bean capacity (g)	Power supply	Dimensions (mm)
1252906	SUPER JOLLY MANUAL - MANUALE	64	1200	220/240V 50/60Hz	195x263x600
1252907	SUPER JOLLY AUTOMATIC - AUTOMATICO	64	1200	220/240V 50/60Hz	195x263x600
1252908	MAJOR MANUAL - MANUALE	83	1200	220/240V 50/60Hz	202x312x620
1252909	MAJOR AUTOMATIC - AUTOMATICO	83	1200	220/240V 50/60Hz	202x312x620
1252910	MINI MANUAL - MANUALE	58	600	220/240V 50/60Hz	158x188x460
5033374	MINI ELETTRONICO TIPO A	64	600	230V 250W 50Hz	168x340x470

-  Attrezzature complete
-  Equipment, complete
-  Kompletogeräte
-  Equipos completos



1252380



1235124



1235126



1235125







1252015



1235127

LF Code	Model	Grinding burrs ø (mm)	Coffee bean capacity (g)	Power supply	Dimensions (mm)
1252380	EL CAFE TRANQUILO 02	60	500	230V 50Hz	170x340x410
1235124	BRASIL	60	1000	230V 50Hz	210x390x470
1235126	KENIA	60	1000	230V 50Hz	210x380x510
1235125	MARFIL	60	2000	230V 50Hz	210x380x600
1252015	EL CAFE TRANQUILO 01	60	500	230V 50Hz	170x340x410
1235127	EL CAFE TRANQUILO TRON	60	500	230V 50Hz	170x340x410

-  Attrezzature complete
-  Equipment, complete
-  Kompletogeräte
-  Equipos completos



1252003



1252002



LF Code	Model	Grinding burrs ø (mm)	Coffee bean capacity (g)	Power supply	Dimensions (mm)
1252003	MINI ON DEMAND	38	500	220V 50/60Hz	165x270x375
1252002	MINI	38	500	220V 50/60Hz	165x270x375



1252620

LF Code	Model	Grinding burrs ø (mm)	Coffee bean capacity (g)	Power supply	Dimensions (mm)
1252620	VARIO ON DEMAND	54	250	200/230V 50/60Hz	125x160x370

# Everything for your coffee grinder



## Macine Heavy duty - Long life

Durata maggiore del **+70%** rispetto ad una macina standard!



## Heavy duty - Long life Grinding burrs

**+70%** longer life cycle compared to a standard grinding burr!



## Mahlscheiben: Heavy duty - Long life

**+70%** längere Lebensdauer gegenüber normalen Mahlscheiben!



## Molinos Heavy duty - Long life

Duración mayor del **+70%** respecto a una muela estándar

Vedi pag. / See page / Siehe Seite / Ver pág. **97**

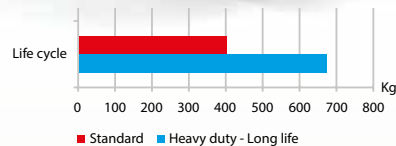

## Prodotti specifici per la pulizia di macine e campane



## Specific products for the cleaning of grinders and hoppers







## Spezialprodukte zur Reinigung der Mahlscheiben und Kaffeebohnenbehälter



## Productos específicos para la limpieza de fresas y tolvas de café

Vedi pagg. / See pages / Siehe Seiten / Ver págs. **59-71**

-  Attrezzature complete
-  Equipment, complete
-  Kompletogeräte
-  Equipos completos





# COMANDANTE®





High-nitrogen martensitic steel







 Macine coniche in acciaio inox trattate con un processo di indurimento che ne garantisce una particolare durezza e resistenza nel tempo.  
Dimensioni ø 61x150 mm.  
Corpo in acciaio inox rivestito in legno.  
Regolazione della macinatura.

 Stainless steel conical burrs treated by an hardening process to guarantee a special hardness and long lasting life.  
Dimension ø 61x150 mm.  
Wood coated stainless steel housing.  
Grinding setting.

 Konische Edelstahlmahlscheibe mit einem spezifischen Härtingsprozess verarbeitet, der eine spezielle Härte und Lebensdauer garantiert.  
Maße ø 61x150 mm.  
Körper aus Edelstahl mit Holz beschichtet.  
Einstellung des Mahlvorgangs möglich.

 Fresas cónicas en acero tratadas con un proceso de endurecimiento que garantiza una dureza particular y una mayor resistencia en el tiempo.  
Medidas ø 61x150 mm.  
Cuerpo de acero inox recubierto de madera.  
Regulación de la molienda.



-  Attrezzature complete
-  Equipment, complete
-  Kompletogeräte
-  Equipos completos

# Handground



1235251



1235250





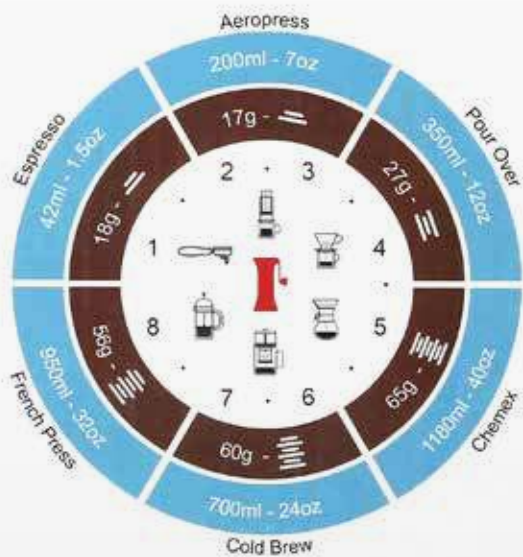

1235252

LF Code	Notes	Dimensions	Model
1235251	100 g	ø 105x210 mm	BLACK
1235250	100 g	ø 105x210 mm	WHITE
1235252	100 g	ø 105x210 mm	NICKEL



-  Brew method
-  Coffee
-  Water
- 1-8 Grind Settings
- Setting between numbers
-  Measurement marks on Handground hopper



-  Attrezzature complete
-  Equipment, complete
-  Kompletogeräte
-  Equipos completos



1235061



1235063



1235064



1235062



1235090







1235101

LF Code	Notes	Dimensions	Model
1235061	40 g	108x70x180 mm	MXR-2TB
1235063	100 g	ø 92x170 mm	MSCS-2TB
1235064	14 g	ø 72x175 mm	MSS-1B
1235062	40 g	ø 105x200 mm	CM-502C
1235090	120 g	ø 110x190 mm	CMHC-4C
1235101	30 g	ø 86x185 mm	MCW-2



**HARIO**



-  Attrezzature complete
-  Equipment, complete
-  Kompletogeräte
-  Equipos completos

## 1235039



### SISTEMA PER CAFFÈ AEROPRESS

per fare un ottimo caffè usando solo la pressione della mano e un po' di acqua calda.



### COFFEE SYSTEM AEROPRESS

to make an excellent coffee using only your hand's pressure and a bit of hot water.



### SYSTEM FÜR KAFFEE AEROPRESS

für einen köstlichen Kaffee nur mit dem Handdruck und ein wenig Warmwasser.



### SISTEMA PARA CAFÉ AEROPRESS

p. hacer cafés exquisitos usando sólo la presión de la mano y un poquito de agua caliente.



1235040



1235041



1235068



LF Code	Notes
1235040	350 FILTERS
1235041	STAINLESS STEEL 150 MICRON
1235068	STAINLESS STEEL 35 MICRON

## 1235141

FELLOW

NEW!



### PRISMO VALVOLA SUPERPOWERS FELLOW

valvola a pressione progettata per AEROPRESS consente un accumulo di pressione per realizzare un caffè stile espresso corpo in polipropilene valvola in silicone filtro in acciaio da 70 micron



### PRISMO VENTIL SUPERPOWERS FELLOW

Druckventil realisiert für AEROPRESS ermöglicht einen Druckaufbau, um Kaffee nach Espresso-Art zu machen Gehäuse aus Polypropylen Silikonventil Stahlfilter von 70 Mikron







### PRISMO VALVE SUPERPOWERS FELLOW

pressure valve designed for AEROPRESS allows a pressure build-up to make an espresso style coffee body of polypropylene silicone valve filter of steel of 70 micron



### PRISMO VÁLVULA SUPERPOWERS FELLOW

válvula de presión diseñada por AEROPRESS permite acumular presión para realizar un café tipo espresso cuerpo de polipropileno válvula de silicona filtro de acero 70 micron

-  Attrezzature complete
-  Equipment, complete
-  Kompletogeräte
-  Equipos completos



1235130



1235043



1235098



1235056



1235129



1235128







1235099



1235044



LF Code	Notes	Dimensions
1235130	1-3 cups	ø 105x210 mm
1235043	2-6 cups	ø 135x213 mm
1235098	1-3 cups	ø 110x210 mm
1235056	2-6 cups	ø 130x220 mm
1235129	6-8 cups	ø 145x230 mm
1235128	8-10 cups	ø 160x235 mm
1235099	1-3 cups	100 FILTERS
1235044	6-8-10 cups	100 FILTERS

-  Attrezzature complete
-  Equipment, complete
-  Komplettgeräte
-  Equipos completos



1235094



1235095



1235117



1235119



1235118



LF Code	Notes	Power supply	Model
1235094	1.0 L	220/240V 50Hz - 1000W	BV382510VC
1235095	1.7 L	220/240V 50/60Hz - 1500W	BV382518VC
1235117	1.0 L	---	BV3825ST
1235119	600 ml	---	BV6600CA
1235118	1-4 CUPS	---	BV4000IDV2



🇮🇹 Attrezzature complete  
🇬🇧 Equipment, complete  
🇪🇸 Kompletogeräte  
🇪🇸 Equipos completos



**E&B**  
L A B  
CRAFTED IN ITALY







🇮🇹 Il gocciolatore in acciaio E&B IMS non è semplicemente un cono filtrante, ma un vero e proprio sistema di estrazione completo, interamente realizzato in acciaio inox. Il tutto è composto da un cono filtrante e una struttura di supporto. Il cono è una membrana di fili d'acciaio inox intrecciati, con una capacità di filtraggio di 35 µm e rappresenta una valida alternativa agli attuali sistemi composti da una tazza di ceramica o altri materiali e un filtro di carta.

🇬🇧 The E&B IMS steel dripper is not only a filtering cone but also a complete extraction system entirely made of stainless steel. A cone filter and a support structure make up the system. The cone is a membrane of woven stainless steel wires, which allows filtering 35 µm and represents a valid alternative to the current systems which are made up of cups made of ceramic or other materials and paper filters.

🇩🇪 Der Kaffeetropfenfilter aus Stahl E&B IMS ist nicht nur ein einfacher Filterkonus, sondern auch ein regelrechtes Extraktionssystem aus Edelstahl. Das komplette System besteht aus einem Filterkonus und einer Supportstruktur. Der Konus ist eine Membran von gewebtem Edelstahlkabeln, der bis zu 35 µm filtert. Es ist eine gute Alternative zu den aktuellen Systemen, die aus Keramiktassen oder anderen Materialien und Papierfiltern bestehen.

🇪🇸 El filtro en acero E&B IMS no es simplemente un cono filtrante si no un verdadero sistema de extracción completo, realizado de acero inoxidable. Está compuesto de un cono filtrante y una estructura de soporte. El cono es una membrana de alambres de acero inoxidable tejidos, con una capacidad de filtrar de 35 µm y representa una válida alternativa a los sistemas actuales compuestos por tazas de cerámica u otros materiales así como el filtro de papel.



-  Attrezzature complete
-  Equipment, complete
-  Kompletogeräte
-  Equipos completos



1235097



1235110



1235112



1235116



1235111







1235113



1235115

LF Code	Notes	Dimensions
1235097	1-4 cups	ø 135x96 mm
1235110	1-4 cups	ø 145x96 mm
1235112	PAINTED IRON - FERRO VERNICIATO	130x149x180 mm
1235116	STAINLESS STEEL - ACCIAIO INOX	130x149x180 mm
1235111	1-4 cups / 560 ml	ø 135x96 mm
1235113	1-4 cups / 800 ml	ø 145x96 mm
1235115	-10+100°C - x 1235111	260 mm

-  Attrezzature complete
-  Equipment, complete
-  Kompletgeräte
-  Equipos completos

# HARIO



1235103







1235106



1235107

LF Code	Notes	Model
1235103	400 ml / 1-4 CUPS / ø 125x225 mm	DGC-40-OV
1235106	300 ml / 1-2 CUPS / ø 75x175 mm	CPSW-2-OV
1235107	680 ml / 3-4 CUPS / ø 95x188 mm	CPSW-4-OV



-  Attrezzature complete
-  Equipment, complete
-  Kompletogeräte
-  Equipos completos



1235052



1235114



1235121



1235070







1235122



1235051

LF Code	Notes	Dimensions	Model
1235052	2 Kg	120x190x28 mm	VST-2000B
1235114	2 Kg	120x175x30 mm	VSTM-2000HSV
1235121	220/240V 50/60Hz	135x230x390 mm	EVCG-8B-E
1235070	---	---	VAS-1
1235122	---	---	VSA-1SV
1235051	---	---	VSS-1T

-  Attrezzature complete
-  Equipment, complete
-  Kompletengeräte
-  Equipos completos

# HARIO



1235048



1235049



1235076



1235057



LF Code	Notes	Colour	Model
1235048	1-2 CUPS	BIANCO/WHITE	VDC-01W
1235049	1-4 CUPS	BIANCO/WHITE	VDC-02W
1235076	1-2 CUPS	ROSSO/RED	VDC-01R
1235057	1-4 CUPS	ROSSO/RED	VDC-02R



1235081







1235082



1235120

LF Code	Notes	Colour	Model
1235081	1-4 CUPS	ARGENTO/SILVER	VDM-02HSV
1235082	1-4 CUPS	RAME/COPPER	VDM-02CP
1235120	1-4 CUPS	RAME/COPPER	VDPC-02CP



-  Attrezzature complete
-  Equipment, complete
-  Kompletogeräte
-  Equipos completos



1235078



1235079



1235088



1235080



LF Code	Notes	Colour	Model
1235078	1-4 CUPS	ROSSO/RED	VDG-02R
1235079	1-4 CUPS	NERO/BLACK	VDG-02B
1235088	1-2 CUPS	NERO/BLACK	VDGN-01B
1235080	1-4 CUPS	NERO/BLACK	VDGN-02B

**NEW!**







5096912

**NEW!**



5088994

LF Code	Notes	Material	Model
5096912	1-2 CUPS	PLASTIC	VD-01T
5088994	1-4 CUPS	PLASTIC	VD-02T

-  Attrezzature complete
-  Equipment, complete
-  Kompletogeräte
-  Equipos completos

# HARIO



1235104



1235105



1235108



1235109

LF Code	Notes	Model
1235104	400 ml	VCWN-40-OV
1235105	600 ml	VCWN-60-OV
1235108	1-2 CUPS	VDG-01-OV
1235109	1-4 CUPS	VDG-02-OV



1235075



1235050



1235083



1235084



1235096







1235086



5078809



LF Code	Notes	Model
1235075	360 ml	XGS-36TB
1235050	600 ml	XGS-60TB
1235083	360 ml	XVD-36B
1235084	600 ml	XVD-60B
1235096	450 ml	VCS-01B
1235086	700 ml	VCS-02B
5078809	700 ml / 1-4 CUPS	VCSD-02-EX

-  Attrezzature complete
-  Equipment, complete
-  Kompletogeräte
-  Equipos completos

# HARIO



1235073



1235074



1235072



1235087

LF Code	Notes	Model
1235073	240 ml / 1-2 CUPS	DPW-1
1235074	480 ml / 3-4 CUPS	DPW-3
1235072	700 ml / 1-4 CUPS	VDD-02B
1235087	800 ml / FOR TEA	TDR-8006T



1235053



1235054



1235091



1235092



1235089







1235093

LF Code	Notes	Model
1235053	1-2 CUPS	VCF-01-100W
1235054	1-4 CUPS	VCF-02-100W
1235091	1-2 CUPS	VCF-01-100M
1235092	1-4 CUPS	VCF-02-100M
1235089	1-2 CUPS	FD-1
1235093	3-4 CUPS	FD-3
1235102	1-2/ 1-4	VPS-100W

1235102



-  Attrezzature complete
-  Equipment, complete
-  Kompletogeräte
-  Equipos completos

# HARIO



**NEW!**

5089903



1235058



5069522





LF Code	Notes	Dimensions	Model
5089903	2-6 CUPS	H 455 mm	WDC-6
1235058	360 ml / 3 CUPS	H 350 mm	TCA-3
5069522	600 ml / 5 CUPS	H 390 mm	TCA-5EX



- 🇮🇹 Attrezzature complete
- 🇬🇧 Equipment, complete
- 🇩🇪 Komplettgeräte
- 🇪🇸 Equipos completos

# HARIO



-  Attrezzature complete
-  Equipment, complete
-  Kompletogeräte
-  Equipos completos

# HARIO



1235069



5078829



1235047



1235085



1235131



1235123

LF Code	Notes	Power supply	Model
1235069	0.9 L	---	VKBN-90CP
5078829	1.0 L	---	VKB-100HSV
1235047	1.2 L	---	VKB-120HSV
1235085	0.8 L	220/240V 50Hz	EVKB-80EHSV
1235131	0.8 L	220/240V 50Hz	EVKT-80E-HSV
1235123	0/110°C	---	VTM-1B

# FELLOW



1235400







1235401



1235402

LF Code	Capacity	Notes	Model
1235400	1.0 L	SUITABLE FOR: GAS - ELECTRIC - INDUCTION	1102
1235401	1.0 L	SUITABLE FOR: GAS - ELECTRIC - INDUCTION	1042
1235402	1.0 L	SUITABLE FOR: GAS - ELECTRIC - INDUCTION	1043

-  Bilance digitali
-  Digital scales
-  Digitalwaagen
-  Balanzas digitales



1017001

1017002



1017004

1017005

LF Code	Description	Maximum capacity (g)	Division (g)	Dimensions (mm)
1017001	DIGITAL SCALE TANITA	120	0,1	156x76x16
1017002	DIGITAL SCALE MIX	600	0,1	127x78x18
1017004	DIGITAL SCALE	500	0,1	119x80x20
1017005	DIGITAL SCALE	300	0,1	220x50







1069001

1069002

1394720

LF Code	Material	Capacity
1069001	PLASTIC	20 ml
1069002	STAINLESS STEEL - INOX	20 ml
1394720	STAINLESS STEEL - INOX	365 ml

-  Bilance digitali
-  Digital scales
-  Digitalwaagen
-  Balanzas digitales



BREWISTA

1017100



g/ml - oz - Lb

NEW!

1017500



g - oz - ct - gn

1017027



g - oz - dwt - gn

SHOCK PROOF

1017026



g

HARIO

1235052







g

HARIO

1235114

LF Code	Description	Maximum capacity (g)	Division (g)	Dimensions (mm)
1017100	TIMER & WEIGHT WATERPROOF - TEMPO E PESO	2000	0,1	105x126x20
1017500	TIMER & WEIGHT - TEMPO E PESO	3000	0,1	130x190x28
1017027	DIMENSIONI RIDOTTE - MINI TABLE TOP	200	0,01	75x110x25
1017026	ANTIURTO - SHOCKPROOF	1000	0,1	142x82x25
1235052	SPECIFICA PER HARIO - FOR HARIO PRODUCTS	2000	0,2/3,0	120x190x28
1235114	SPECIFICA PER HARIO - FOR HARIO PRODUCTS	2000	0,2/3,0	120x190x28





-  **Bilance digitali**
-  **Digital scales**
-  **Digitalwaagen**
-  **Balanzas digitales**

# acaia



 La suite completa delle app Acaia è progettata per tutti i livelli di erogazione del caffè. Tutte le app sono gratuite e si connettono alle bilance smart Acaia via Bluetooth.





 The full suite of Acaia apps is designed for every level of coffee brewing. All the apps are free and connect to the Acaia smart scales via Bluetooth technology.

 Die komplette Palette von Acaia Apps wurde für jeden Vorbereitungsschritt konzipiert. Alle Apps sind kostenlos und können sich mit den Acaia Smart-Waagen durch Bluetooth verbinden.

 La suite completa de la app Acaia esta diseñada para todos los niveles de erogación del café. Todas las aplicaciones son gratuitas y pueden conectarse a las balanzas Acaia smarts via Bluetooth.



LF Code	Description	Maximum capacity (g)	Division (g)	Dimensions (mm)
<b>1017200</b>	LUNAR	2000	0,1	105x105x15
<b>1017201</b>	PEARL WHITE	2000	0,1	160x160x32
<b>1017202</b>	PEARL BLACK	2000	0,1	160x160x32

-  **Bilancia digitale**
-  **Digital scales**
-  **Digitalwaagen**
-  **Balanzas digitales**



**Escali®**

 **BILANCIA DIGITALE  
5000g/11lb/175oz**

dimensioni 250x150x20 mm  
batterie incluse  
unità di misura: g - lb - oz - ml - floz  
precisione: 1gr - 0,1oz  
funzione OFF automatica dopo 5 minuti  
funzione TARA  
funzione BLUETOOTH per dialogare con smartphone e usufruire delle innumerevoli funzioni della APP creata appositamente per questa bilancia. colore NERO

 **DIGITAL SCALE  
5000g/11lb/175oz**

dimensions 250x150x20 mm  
batteries included  
units of measure : g - lb - oz - ml - floz  
accuracy: 1 g - 0.1oz  
automatic switch OFF mode after 5 minutes  
TARE function  
BLUETOOTH function to connect with smartphones and use the APP and its countless functions that was specially designed for this scale. COLOUR: BLACK

**1017023**



 **DIGITALWAAGE  
5000g/11lb/175oz**

Abmessungen 250x150x20 mm  
Batterien inbegriffen  
Maßeinheiten : g - lb - oz - ml - floz  
Präzision: 1g - 0,1oz  
automatische Ausschaltfunktion nach 5 Minuten  
Tariierfunktion  
Bluetooth-Funktion mit Smartphone Verbindung.  
Speziell für diese Waage entworfene App mit vielen Funktionen.  
Farbe: SCHWARZ

 **BALANZA DIGITAL  
5000g/11lb/175oz**

medidas 250x150x20 mm  
baterías incluidas  
unidad de medición : g - lb - oz - ml - floz  
precisión: 1 g - 0,1oz  
función de OFF automática después de 5 minutos  
función de TARA  
función Bluetooth para comunicar con los smartphon aprovechar las muchas funciones de APP creado especialmente para esta báscula. COLOR NEGRO

LF Code	Description	Maximum capacity (g)	Division (g)	Dimensions (mm)
1017023	FUNZIONE BLUETOOTH - BLUETOOTH FUNCTION	5000g/11lb/175oz	1g - 0.1oz	250x150x20







 Bilancia con funzione **Bluetooth**, per dialogare con il tuo smartphone e sfruttare le innumerevoli funzioni della APP creata appositamente per questa bilancia.

 A scale with **Bluetooth** functionality which allows you to connect with your smartphone and use the many functions of the APP, that have been specially designed for this scale.

 Die **Bluetooth** Funktion dieser Waage macht es möglich sie mit ihrem Smartphone zu verbinden und so die zahlreichen Funktionen der für diese Waage speziel entworfenen App zu benutzen.

 Balanza con función **Bluetooth**, para interactuar con su Smartphone y disfrutar de la numerosas funciones de la APP diseñada especialmente para esta balanza.



-  **Bilance digitali**
-  **Digital scales**
-  **Digitalwaagen**
-  **Balanzas digitales**

# Escali®

 **BILANCIA DIGITALE  
7000g/15lb/248oz**

dimensioni 230x160x20 mm  
batterie incluse  
unità di misura: gr - lb - oz -  
floz - ml  
precisione: 1gr - 0,1oz  
funzione OFF automatica  
dopo 5 minuti  
funzione TARA  
funzione HOLD mantiene  
visualizzato il peso anche  
dopo aver rimosso la merce  
in BAMBÙ

 **DIGITALWAAGE  
7000g/15lb/248oz**

Abmessungen 230x160x20 mm  
Batterien inbegriffen  
Maßeinheiten : g - lb - oz -  
floz - ml  
Präzision: 1g - 0,1oz  
automatische Ausschaltfunk-  
tion nach 5 Minuten  
Tariertfunktion  
HOLD-Funktion hält die  
Gewichtsanzeige auch  
nachdem die Ware entfernt  
worden ist  
aus BAMBOO

 **DIGITAL SCALE  
7000g/15lb/248oz**

dimensions 230x160x20 mm  
batteries included  
units of measure : g - lb - oz  
- floz - ml  
accuracy: 1 g - 0.1oz  
automatic switch OFF mode  
after 5 minutes  
TARE function  
with the HOLD function, the  
weight is displayed also after  
the goods have been removed  
made of BAMBOO

 **BALANZA DIGITAL  
7000g/15lb/248oz**

medidas 230x160x20 mm  
baterías incluidas  
unidad de medición : g - lb -  
oz - floz - ml  
precisión: 1 g - 0,1oz  
función de OFF automática  
después de 5 minutos  
función de TARA  
la función HOLD muestra el  
indicador de peso también  
después de retirar los  
productos  
de BAMBÚ

## 1017014



LF Code	Description	Maximum capacity (g)	Division (g)	Dimensions (mm)
1017014	BAMBÙ - BAMBOO	7000g/15lb/248oz	1g - 0.1oz	230x160x20

 **BILANCIA DIGITALE  
5000g/11lb/175oz**

dimensioni 223x223x135 mm  
batterie incluse  
unità di misura: g - lb - oz -  
ml - floz  
precisione: 1g - 0,1oz  
funzione OFF automatica  
dopo 5 minuti  
funzione TARA  
vaschetta inclusa  
INOX

 **DIGITALWAAGE  
5000g/11lb/175oz**

Maße 223x223x135 mm  
Batterien inbegriffen  
Maßeinheiten : g - lb - oz -  
ml - floz  
Präzision: 1g - 0,1oz  
automatische Ausschalt-  
funktion nach 5 Minuten  
Tariertfunktion  
Wiegeschale inbegriffenert  
EDELSTAHL

 **DIGITAL SCALE  
5000g/11lb/175oz**

dimensions 223x223x135 mm  
batteries included  
units of measure : g - lb - oz  
- ml - floz  
accuracy: 1 g - 0.1oz  
automatic switch OFF mode  
after 5 minutes  
TARE function  
tray included  
stainl. steel

 **BALANZA DIGITAL  
5000g/11lb/175oz**

medidas 223x223x135 mm  
baterías incluidas  
unidad de medición : g - lb -  
oz - ml - floz  
precisión: 1 g - 0,1oz  
función de OFF automáti-  
ca después de 5 minutos  
función de TARA  
cubeta incluida  
A. INOX

## 1017024



LF Code	Description	Maximum capacity (g)	Division (g)	Dimensions (mm)
1017024	INOX - INOX	5000g/11lb/175oz	1g - 0.1oz	223x223x135

-  Caffettiere
-  Coffee pots
-  Kaffeekannen
-  Cafeteras



1224027



1228001



1228002



1228003



1228004



1228009



1228005

LF Code	Model	Cups	Suitable for	Width (mm)	Height (mm)	Notes
1224027	MOKA EXPRESS	3	GAS - ELECTRIC - GLASS CERAMIC	90	158	NOT DISHWASHER SAFE
1228001	MOKA EXPRESS	6	GAS - ELECTRIC - GLASS CERAMIC	108	210	NOT DISHWASHER SAFE
1228002	MOKA EXPRESS	9	GAS - ELECTRIC - GLASS CERAMIC	116	245	NOT DISHWASHER SAFE
1228003	MOKA EXPRESS	3	GAS - ELECTRIC - GLASS CERAMIC	90	158	NOT DISHWASHER SAFE
1228004	MOKA EXPRESS	6	GAS - ELECTRIC - GLASS CERAMIC	108	210	NOT DISHWASHER SAFE
1228009	MOKA EXPRESS	3	GAS - ELECTRIC - GLASS CERAMIC	90	158	NOT DISHWASHER SAFE
1228005	MOKA EXPRESS	6	GAS - ELECTRIC - GLASS CERAMIC	108	210	NOT DISHWASHER SAFE



1228010



1228006



1228007



1228008



LF Code	Model	Cups	Suitable for	Width (mm)	Height (mm)	Notes
1228010	VENUS	2	GAS - ELECTRIC - GLASS CERAMIC	81	127	DISHWASHER SAFE
1228006	VENUS	4	GAS - ELECTRIC - GLASS CERAMIC - INDUCTION	98	172	DISHWASHER SAFE
1228007	VENUS	6	GAS - ELECTRIC - GLASS CERAMIC - INDUCTION	107	200	DISHWASHER SAFE
1228008	VENUS	10	GAS - ELECTRIC - GLASS CERAMIC - INDUCTION	128	245	DISHWASHER SAFE



1235140



LF Code	Model	Cups	Suitable for	Width (mm)	Height (mm)	Notes
1235140	MILK FROTHER / MONTALATTE	330 ml	GAS - ELECTRIC - GLASS CERAMIC	103	220	NOT DISHWASHER SAFE

-  Cassetti
-  Drawers
-  Kaffeesatz-Abklopfkästen
-  Cajones



1480761



Stainless Steel

1480760

LF Code	Material	Dimensions (mm)
1480761	ALUMINIUM - ALLUMINIO	115x115x130
1480760	STAINLESS STEEL - INOX	180x140x115



Stainless Steel

1480770

LF Code	Material	Mounting hole (mm)
1480770	STAINLESS STEEL - INOX	146x146



1480766



1480767



1480768



1480005

LF Code	Material	Dimensions (mm)
1480766	PLASTIC - PLASTICA	ø 119x102
1480767	PLASTIC - PLASTICA	ø 119x102
1480768	PLASTIC - PLASTICA	ø 119x102
1480005	MARMO - MARBLE	ø 148x151



1480764



1480763

LF Code	Material	Dimensions (mm)
1480764	WOOD/PLASTIC - LEGNO/PLASTICA	132x132x135
1480763	WOOD/PLASTIC - LEGNO/PLASTICA	135x135x135



1480752



1480753



1480754



1480755

LF Code	Material	Dimensions (mm)
1480752	STAINLESS STEEL - INOX	305x365x105
1480753	STAINLESS STEEL - INOX	450x320x105
1480754	STAINLESS STEEL - INOX	370x280x105
1480755	STAINLESS STEEL - INOX	305x235x105



1480758



1480756

LF Code	Material	Dimensions (mm)
1480758	STAINLESS STEEL - INOX	265x200x85
1480756	STAINLESS STEEL - INOX	315x270x85





**1480200**



**1080170**



**1080270**

LF Code	Material	Dimensions (mm)
<b>1480200</b>	STAINLESS STEEL - INOX	355x250x85
<b>1080170</b>	STAINLESS STEEL - INOX	350x250x90
<b>1080270</b>	STAINLESS STEEL - INOX	250x180x90



**1080370**







**1080371**







**1080914**

LF Code	Material	Dimensions (mm)
<b>1080370</b>	STAINLESS STEEL - INOX	175x165x155
<b>1080371</b>	STAINLESS STEEL - INOX	170x160x150
<b>1080914</b>	STAINLESS STEEL - INOX	175x161x97

-  Cassetti
-  Drawers
-  Kaffeesatz-Abklopfkästen
-  Cajones

-  Sfiati superiori per fuoriuscita vapore
-  Upper vents for steam outlet
-  Obere Öffnungen zum Dampausfluss
-  Respiraderos superiores para salida del vapor



-  Barra triangolare per migliorare la caduta della cialda esausta
-  Triangular bar to improve the fall of the used pod
-  Dreieckiger Stab, um den Fall des erschöpften Pods zu verbessern
-  Barra triangular para mejorar la caída de la cápsula usada

Stainless Steel



5092769

Stainless Steel



5092767

Stainless Steel



1480020

Stainless Steel



5092766

Stainless Steel



5092768





Stainless Steel



5092765



LF Code	Material	Dimensions (mm)
5092769	STAINLESS STEEL - INOX	425x280x100
5092767	STAINLESS STEEL - INOX	360x215x85
1480020	STAINLESS STEEL - INOX	370x280x85
5092766	STAINLESS STEEL - INOX	370x265x85
5092768	STAINLESS STEEL - INOX	225x165x95
5092765	STAINLESS STEEL - INOX	245x245x152

-  Cassetti
-  Drawers
-  Kaffeesatz-Abklopfkästen
-  Cajones



Stainless Steel

1080162



Stainless Steel

1080163



LF Code	Material	Dimensions (mm)
1080162	STAINLESS STEEL - INOX	ø 170x110
1080163	STAINLESS STEEL - INOX	ø 110x150



1480751

 **CASSETTA LEGNO 6 SCOMPARTI THE**

dimensioni 225x155x95 mm

 **6 COMPARTMENT WOODEN TEA BOX**





dimensions 225x155x95 mm

 **BOX AUS HOLZ MIT 6 FÄCHERN FÜR TEEBEUTEL**

Größe 225x155x95 mm

 **CAJA MADERA 6 COMPARTIMENTOS TÉ**

medidas 225x155x95 mm

-  Cassetti
-  Drawers
-  Kaffeesatz-Abklopfkästen
-  Cajones

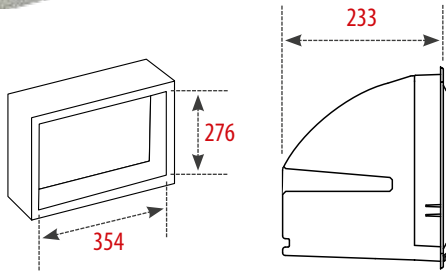

**3080100**

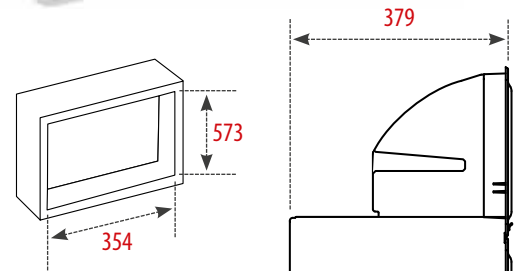

**3080101**



**2102741**



Photo	LF Code	Dimensions (mm)	Mounting hole (mm)
1	<b>3080100</b>	377x299x233	354x276
2	<b>3080101</b>	277x599x379	354x573
3	<b>2102741</b>	311	---



**1480007**



LF Code	Dimensions (mm)	Mounting hole (mm)	Notes
<b>1480007</b>	240x380x115	FOR COUNTER TOP - DA BANCO	KNOCKBOX - BATTIFONDI



3080001

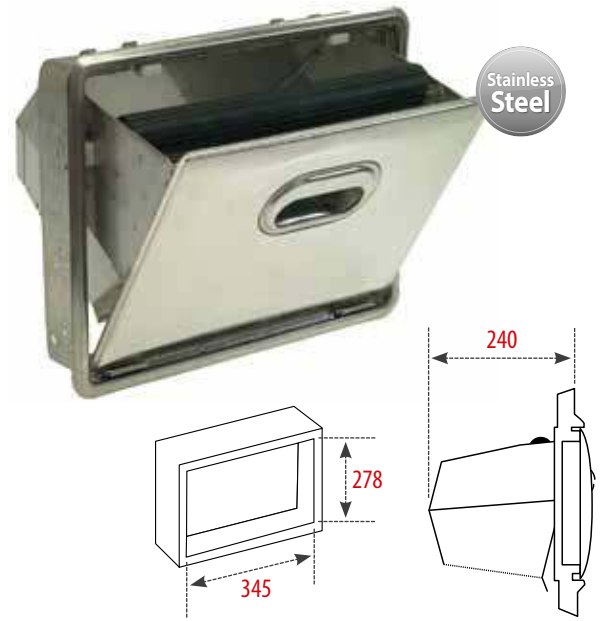

3080011

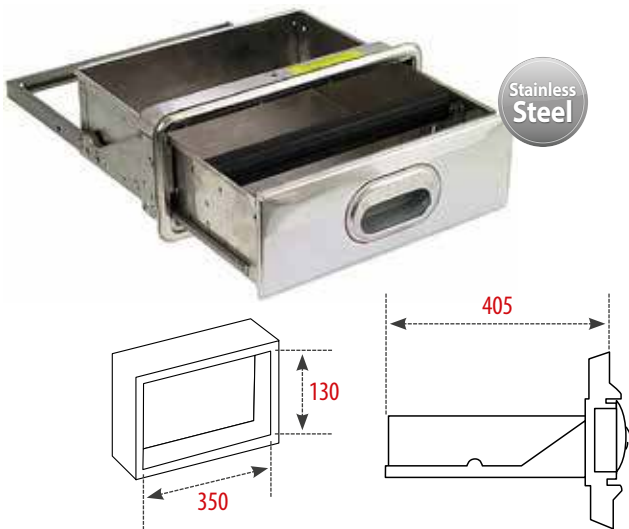

3080002

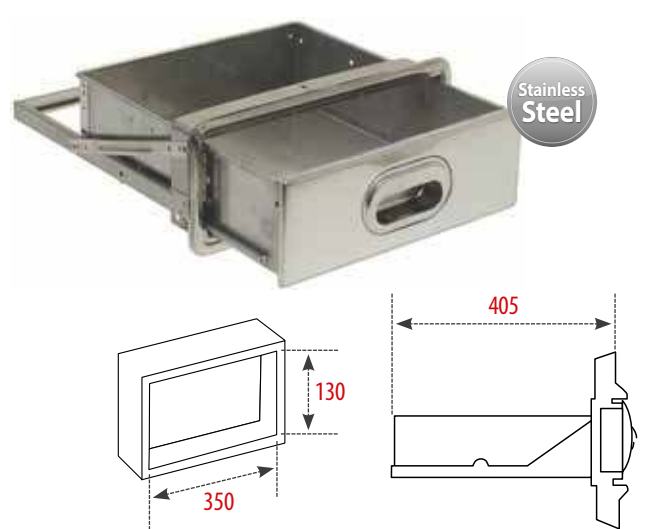

3080006







3080003













3080903





LF Code	Dimensions (mm)	Mounting hole (mm)	Notes
3080001	345x240x270	345x278	KNOCKBOX - BATTIFONDI
3080011	345x240x270	345x278	KNOCKBOX - BATTIFONDI
3080002	347x405x132	350x130	KNOCKBOX - BATTIFONDI
3080006	347x405x132	350x130	SPECIMEN - PORTAOGGETTI
3080003	∅ 39x320	SUGGESTED - CONSIGLIATO	---
3080903	∅ 39x320	SUITABLE - COMPATIBILE	---





-  Contenitori sottovuoto
-  Vacuum food containers
-  Vakuumierbehälter
-  Contenedores al vacío



-   fuori l'aria
-  fuori l'ossigeno
-  ossidazione quasi assente
-  lunga conservazione degli alimenti e dei sapori

-   air out
-  oxygen out
-  almost absent oxidisation
-  food and tastes long preservation

-   Luft raus
-  Sauerstoff raus
-  Fast keine Oxydation
-  Konservierung von Lebensmitteln und Geschmack

-   fuera aire
-  fuera oxígeno
-  oxidación casi inexistente
-  aumenta la conservación de los alimentos y los sabores

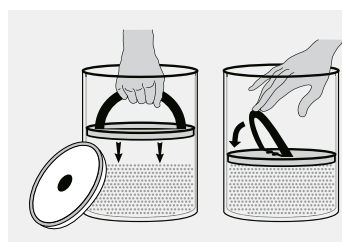

 Tutti i contenitori sono completi di valvola per il sottovuoto. Elimina l'aria con un semplice movimento.

 All containers are equipped with a vacuum valve. It eliminates air with a simple movement.

 Alle Behälter haben ein Vakuüm Ventil. Luftabsaugung durch einen einfachen Handgriff.

 Todos los contenedores están completos de válvulas para el vacío. Elimina el aire con un simple movimiento.



1452008



1452009



LF Code	Colour	Capacity (ml)	Dimensions (mm)
1452008	GLASS	850	ø 125x108
1452009	GLASS	1800	ø 125x180



1452001



1452002



1452005



1452007

LF Code	Colour	Capacity (ml)	Dimensions (mm)
1452001	BLACK	850	ø 120x108
1452002	CHROME	850	ø 120x108
1452005	MOCHA	850	ø 120x108
1452007	RED	850	ø 120x108



1452010



1452011







1452015



1452013

LF Code	Colour	Capacity (ml)	Dimensions (mm)
1452010	BLACK	1800	ø 120x180
1452011	CHROME	1800	ø 120x180
1452015	PEARL	1800	ø 120x180
1452013	RED	1800	ø 120x180

-  Cucchiaini caffè-cappuccino-latte
-  Spoons for coffee-cappuccino-milk
-  Löffel für Kaffee-Cappuccino-Milch
-  Cucharas café-cappuccino-leche



Stainless Steel

1881001



Stainless Steel

1881002



Stainless Steel

1881003







Stainless Steel

1881004

LF Code	Teaspoon for	Material	Length (mm)
1881001	COFFEE	STAINLESS STEEL - INOX	110
1881002	CAPPUCCINO	STAINLESS STEEL - INOX	125
1881003	MILK	STAINLESS STEEL - INOX	205
1881004	TASTING - ASSAGGIO	STAINLESS STEEL - INOX	180



-  Cucchiaini caffè-cappuccino-latte
-  Spoons for coffee-cappuccino-milk
-  Löffel für Kaffee-Cappuccino-Milch
-  Cucharas café-cappuccino-leche



Stainless  
Steel

1394704



Stainless  
Steel





1394705



Stainless  
Steel

1394706

LF Code	Teaspoon for	Material	Length (mm)
1394704	COFFEE	STAINLESS STEEL - INOX	108
1394705	CAPPUCCINO	STAINLESS STEEL - INOX	140
1394706	MILK	STAINLESS STEEL - INOX	210

-  Detergenti
-  Detergents
-  Reinigungsmittel
-  Detergentes



## La cultura del caffè

Cura, igiene, attrezzature, accessori e strumenti per baristi professionisti

### La qualità del caffè è alla base del vostro successo

Una buona posizione e un ambiente confortevole sono importanti ma è la qualità del caffè, abbinata ad igiene e presentazione, a fidelizzare il cliente.

### I fattori decisivi per un caffè perfetto:

- Alta qualità di torrefazione e miscele
- Alta qualità dell'acqua (vedi addolcitori, cartucce filtro)
- Alta qualità delle macchine caffè e macinacaffè
- Filtri di precisione e docce per professionisti
- Prodotti specifici per igiene e pulizia

**Tutti questi accorgimenti vengono vanificati se non sono accompagnati da una sistematica pulizia della macchina del caffè e del macinacaffè con il prodotto giusto**

### Da sapere:

La tostatura dei grani provoca lo scioglimento dei grassi del caffè. Questi si ossidano rapidamente (circa 18/24 ore) e, se lasciati nella macchina, conferiscono un retrogusto sgradevole, amaro e rancido, al vostro caffè.

### Un consiglio per il barista professionista:

- Pulite la vostra macchina del caffè e il vostro macinacaffè ogni giorno (massimo ogni 48 ore)
- Controllate e sostituite periodicamente le macine del macinacaffè
- Non usate detergenti generici, ma scegliete prodotti specifici per i professionisti del caffè (es. Coffee Clean, Scale Clean, e tutti i detergenti e disincrostanti LF)
- Usate addolcitori per l'acqua o filtri cartuccia per ottenere un'ottimale qualità dell'acqua



## Kaffee Kultur

Pflege, Hygiene, Ausstattung, Zubehör und Werkzeuge für professionelle Baristas

### Die Kaffeequalität ist der Schlüssel Ihres Erfolges

Eine gute Lage und eine angenehme Umgebung sind natürlich wichtig aber zuerst ist die Kaffee-Qualität, zusammen mit Sauberkeit und Präsentation, was Stammkunden bindet.

### Die entscheidenden Faktoren des perfekten Kaffees:

- Hohe Qualität der Röstung und der Mischung
- Hohe Wasserqualität (siehe auch Enthärter / Wasserfilter)
- Hohe Qualität der Espressomaschine und der Mühle
- Präzisionsfilter und Duschen für Profis
- Spezielle Reinigungs- und Pflegeprodukte

**All das ist aber nutzlos, wenn Maschine und Mühle nicht gründlich und regelmäßig mit dem richtigen Produkt gereinigt werden**

### Wichtig:

Der Röstprozess setzt Kaffee-Fette frei, die sich auflösen und sehr schnell oxidieren (ca. 18/24h). Wenn Kaffee-Fette in der Maschine lange Zeit bleiben, verleihen sie dem Kaffee einen unerwünschten bitteren und ranzigen Beigeschmack.

### Unser Tipp:

- Maschine und Mühle jeden Tag reinigen (max. alle 48 Stunden).
- Mahlscheiben regelmäßig prüfen und, wenn nötig, auswechseln.
- Verwenden Sie keine Haushaltsreiniger sondern spezielle Reinigungs- und Pflegeprodukte für Kaffeeprofis (z.B. Coffee Clean, Scale Clean und alle LF Reinigungsmittel)
- Verwenden Sie Wasserfilter und Enthärter, um die richtige Wasserqualität zu erhalten.



## The culture of coffee

Care, hygiene, equipment, accessories and tools for passionate professionals

### The quality of coffee is the key factor to your success

A nice location and a welcoming setting are important but it is the coffee quality, combined with hygiene and presentation, which makes the loyal customer.

### The perfect coffee is made of:

- High quality roasting and blends
- High quality water (see softeners /cartridge filters)
- High quality coffee machines and grinders
- Precision filters and showers for professionals
- Specially designed cleaning products

**All the above becomes useless if your coffee machine and grinder are not regularly cleaned with the right product**

### Important:

The roasting process of coffee beans causes coffee fat to melt. Fat oxidizes quickly (approx. 18/24 hours) and, if left in the grinder, it will make your coffee taste unpleasantly bitter and rancid.

### A piece of advice:

- Clean your coffee machine and your grinder every day (max 48 hrs)
- Check and replace your coffee grinder's burr on a regular basis
- Do not use generic detergents. Instead, choose products specially designed for coffee professionals (i.e. Coffee Clean, Scale Clean and all LF detergents)
- Use water softeners or cartridge filters to reach the right water quality



## La cultura del café

Cuidado, higiene, equipos, accesorios y herramientas para baristas profesionales

### La calidad del café es decisiva para su éxito

Una buena ubicación y un entorno confortable son importantes, pero es la calidad del café combinada con la higiene y una buena presentación, los elementos fundamentales para la fidelización de clientes.

### Factores decisivos para la mejor calidad del café:

- Calidad del tueste y de la mezcla del café
- Calidad del agua (ver también depuradores/filtros de cartucho)
- Calidad de la máquina café y del molino
- Filtros y duchas de precisión para profesionales
- Productos químicos específicos para higiene y limpieza

**Todas las precauciones son totalmente frustradas si no vienen acompañadas de una sistemática y frecuente limpieza e higiene de la máquina café y del molino**





### A saber:

El tueste de los granos de café provoca la disolución de las grasas bien identificables por su brillo.

Estas grasas se oxidan rápidamente (aprox. 18/24h) y transfieren al café un gusto desagradable (amargo - rancio).





### Reglas para el buen barista:

- Proceder a limpiar e higienizar la máquina del café y el molino cada 24h (max 48h)
- Controlar y sustituir periódicamente las muelas del molino
- Para la limpieza no utilizar productos genéricos, solo especificados por los profesionales del café (por ejemplo productos línea pulyCaff, Urnex o Coffee Clean)
- Utilizar depuradores automáticos o filtros de cartucho

-  Detergenti
-  Detergents
-  Reinigungsmittel
-  Detergentes





# Grind Cleaner 340 g

-  Il nuovo detergente LF per la pulizia delle macine
-  The new LF cleaning detergent for grinders
-  Das neue LF Reinigungsmittel zur Reinigung der Mahlscheiben
-  Nuevo detergente LF para la limpieza de las fresas



**1092213**

 Detergente per la pulizia delle macine. Ingredienti a base di grano naturale. **100% biologico**

 Detergent for grinders. Natural grain-based ingredients. **100% organic**

 Mittel zur Reinigung der Mahlscheiben. Natürliche Inhaltsstoffe auf Getreidebasis. **100% biologisch**





 Detergente para la limpieza de las fresas. Producto a base de trigo natural. **100% biológico**

**Etichetta personalizzabile da 50 unità in su**

**Personalised label is available for 50 units and above**

**Individuell gestaltbares Etikett ab 50 Einheiten**

**Etiqueta personalizable para 50 o más unidades**

-  Detergenti
-  Detergents
-  Reinigungsmittel
-  Detergentes



3092274



3092275



3092270



3092271



3092272



3092273

LF Code	Description	Notes
3092274	DETERGENT CLEAR CLEAN PLUS	6 Kg
3092275	DETERGENT CLEAR CLEAN PLUS	12 Kg
3092270	DETERGENT CLEAR CLEAN	6 Kg
3092271	DETERGENT CLEAR CLEAN	12 Kg
3092272	SHINE CLEAN RINSE AID	5 Kg
3092273	SHINE CLEAN RINSE AID	10 Kg

 Personalizza gli articoli con il  
**Tuo Logo**

Quantità minime e costi di personalizzazione a richiesta

 Spezieller Aufdruck mit  
**Ihrem Logo**

Mindestbestellmengen und Kosten auf Anfrage

 Special customisation with  
**Your Logo**

Min. quantities and costs quoted on request

 Personalización de los artículos  
**Su Marca**

Cantidad mínima y costes de personalización a medida





3092143



3092543



3092350



3092351



3092352



3092353

LF Code	Description	Notes
3092143	DETERGENT COFFEE CLEAN	900 g
3092543	DETERGENT COFFEE CLEAN	500 g
3092350	DETERGENT COFFEE CLEAN	60 TABS 2.5 g
3092351	DETERGENT COFFEE CLEAN	15 BAGS 20 g
3092352	SCALE REMOVER SCALE CLEAN	1 Kg
3092353	SCALE REMOVER SCALE CLEAN	12 BAGS 25 g







3092355



1092213

LF Code	Description	Notes
3092355	DETERGENT CAPPUCCINO PERFECT	1 L
1092213	DETERGENT GRIND CLEANER	340 g

-  Detergenti
-  Detergents
-  Reinigungsmittel
-  Detergentes

# lujo<sup>®</sup>CLEAN

*for that perfect coffee pleasure!*



Private label  
for 50 pcs



1092211



1092210



1092209







1092200



1092201

LF Code	Description	Notes
1092211	DETERGENT LUJO POWDER/PULVERE	1 Kg
1092210	DETERGENT LUJO POWDER/PULVERE	500 g
1092209	DETERGENT LUJO GRANULAR/GRANULARE	1 Kg
1092200	DETERGENT LUJO MILK FROTHER	1 L
1092201	DETERGENT LUJO MILK FROTHER	45 TABS 16 g each

-  Detergenti
-  Detergents
-  Reinigungsmittel
-  Detergentes



1092220



1092221



1092222







1092223



1092224

LF Code	Description	Notes
1092220	DESCALER TWO IN ONE LUJO	250 ml
1092221	DESCALER LUJO TABLETS	30 TABS 16 g each
1092222	DESCALER LUJO LC	750 ml
1092223	DESCALER LUJO GREENIE	750 ml
1092224	DESCALER LUJO LJ	700 ml

-  Detergenti
-  Detergents
-  Reinigungsmittel
-  Detergentes



**lujo CLEAN**<sup>®</sup>  
 for that perfect coffee pleasure!



1092202



1092203



1092204



1092205



1092206







1092207



1092208

LF Code	Description	Notes
1092202	DETERGENT LUJO TABLETS	120 TABS 1.1 g each
1092203	DETERGENT LUJO TABLETS	120 TABS 1.3 g each
1092204	DETERGENT LUJO TABLETS	150 TABS 1.6 g each
1092205	DETERGENT LUJO TABLETS	100 TABS 2.0 g each
1092206	DETERGENT LUJO TABLETS	200 TABS 2.0 g each
1092207	DETERGENT LUJO TABLETS	90 TABS 3.0 g each
1092208	DETERGENT LUJO TABLETS	100 TABS 3.6 g each



-  Detergenti
-  Detergents
-  Reinigungsmittel
-  Detergentes



1092001



3092243



3092095

LF Code	Description	Notes
1092001	DETERGENT EXPRESS	100 TABS 1.0 g each
3092243	DETERGENT EXPRESS LC	1 L
3092095	SCALE REMOVER BOILERS	6 Kg



3092250



3092252







3092251



2102846



LF Code	Description	Notes
3092250	SCALE REMOVER RIO	250 ml
3092252	DETERGENT COFFEE MAKER CLEANER	6 TABS
3092251	DETERGENT DE-CAF	10 BAGS 30 g each
2102846	DETERGENT DE-CAF	1 BAG 30 g

-  Detergenti
-  Detergents
-  Reinigungsmittel
-  Detergentes



3092074



3092075



3092077



3092078



3092079



3092253







3092080



3092249

LF Code	Description	Notes
3092074	DETERGENT PULY CAFF PLUS	900 g
3092075	DETERGENT PULY CAFF PLUS	570 g
3092077	DETERGENT PULY CAFF PLUS	370 g
3092078	DETERGENT PULY CAFF PLUS	10 BAGS
3092079	DETERGENT PULY CAFF PLUS	60 TABS 2.5 g each
3092253	DETERGENT PULY CAFF PLUS	100 TABS 1.35 g each
3092080	DETERGENT PULY CAFF PLUS	100 TABS 1.0 g each
3092249	DETERGENT PULY CAFF PLUS	70 TABS 0.5 g each

-  Detergenti
-  Detergents
-  Reinigungsmittel
-  Detergentes



3092076



HACCP

3092326



NEW!

HACCP

1092017



3092089



NSF

3092090

-  Detergente consigliato per Moka
-  Suggested cleaner for Moka
-  Empfohlener Reiniger für Moka
-  Detergente sugerido para Moka

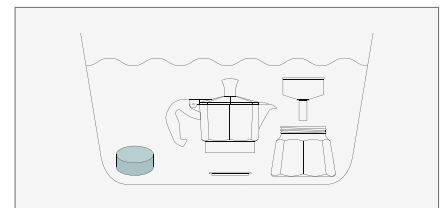

LF Code	Description	Notes
3092076	DETERGENT PULY GRIND CRISTALLI	10 BAGS
3092326	DETERGENT BAR STERYL IGIENIC	1 L
1092017	DETERGENT PULY GRIND HOPPER	200 ml
3092089	DETERGENT PULY CLEANER BABY	10 BAGS 30 g each
3092090	DETERGENT PULY CAFF BREW	120 TABS 4 g each



NSF

3092085



NSF

3092254



NSF

3092088

LF Code	Description	Notes
3092085	DETERGENT PULY MILK PLUS	1 L
3092254	DETERGENT PULY MILK PLUS	14x25 ml
3092088	DETERGENT PULY MILK PLUS	4x25 ml



3092242



LF Code	Description	Notes
3092242	DETERGENT KIT PULY CAFF	---



1092020



1092021



1092023



1092022

LF Code	Description	Notes
1092020	DETERGENT PULY CAFF GREEN	1 Kg
1092021	DETERGENT PULY CAFF GREEN	510 g
1092023	SCALE REMOVER PULY DESCALER ESPRESSO	2x120 ml
1092022	DETERGENT PULY CAFF PLUS	120x3.5 g

1092018



 **DETERGENTE IGIENIZZANTE PULY CAPUCINO**

Sistema detergente e risciacquo igienizzante per macchine caffè automatiche e cappuccinatori con latte fresco.

Conforme al protocollo HACCP.

Confezione 2 flaconi da 1L.

1° step flacone giallo detergente elimina totalmente i residui e il grasso del latte.

2° step flacone azzurro igienizzante coadiuva nel risciacquo l'azione igienica. Uso professionale.

 **SANITIZING DETERGENT PULY CAPUCINO**

Cleaning system and sanitizing rinsing for automatic coffee machines and milk frothers with fresh milk.

In accordance with HACCP protocol. Package 2 bottles of 1 L.

1st step yellow detergent bottle removes milk residues and milk fat. 2nd step blue sanitizing bottle helps in rinsing the hygienic action. Professional use.

 **DESINFEKTIONSREINIGER PULY CAPUCINO**

Reinigungs- und Desinfektionssystem für Kaffeeautomaten und Milchaufschäumer mit Frischmilch. Nach HACCP-Protokoll.

Packung 2 Flaschen - 1L.

1. Schritt Flasche mit gelbem Reinigungsmittel entfernt Milchrückstände und Milchfett.

2. Schritt Flasche m/blauem Desinfektionsreiniger Hilft die hygienische Wirkung im Ausspülen. Für professionelles Gebrauch.

 **DETERGENTE HIGIENIZANTE PULY CAPUCINO**

Sistema de limpieza y aclarado higienizante para máquinas de café automáticas y capuchinadoras con leche fresca.

De acuerdo con protocolo HACCP.

Paquete 2 botellas de 1L.

1° paso botella amarilla detergente elimina totalmente los residuos y la grasa de leche. 2° paso botella azul desinfectante ayuda en el aclarado la acción higiénica. Aplicación profesional.

## Why cleaning plus hygiene?

Milk is a white emulsion mainly consisting of water and protein, carbohydrates, fats, calcium etc.

Heat tends to modify the milk's structure when in direct contact with a heating surface and tends to hydrolyse, sticking inside the equipment and forming solid residues difficult to break up.

In automatic cappuccino makers and in milk frother circuits, in fact, encrustations are created that are known in dairy industries as "milk stone", made up by calcium salts which, in turn, incorporate the milk's organic substances thus forming a fertile ground for the growth and development of unwanted micro-organisms.





For the hygienic safety of the milk served, therefore, at least a daily cleaning is recommended.



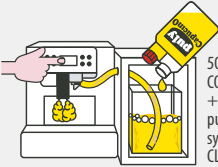

**pulyCapucino™ system integrated used every day, assures the complete elimination of all internal and external residues, with an absolute guarantee of hygiene.**

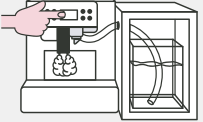
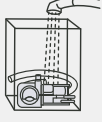
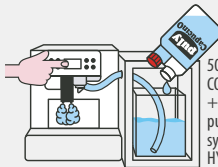
**Thanks to this, the steam quality increases, utilisation times are reduced and the micro-texture of the milk's cream improves.**

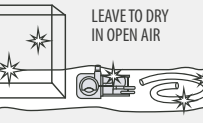
**pulyCapucino™ system integrated does not contain substance harmful for the cappuccino maker and doesn't leave noxious residues for the consumer.**

Professional use.

AUTOMATIC SYSTEM	IMMERSION SYSTEM
<p><b>1 - CLEANING</b></p>  <p>500 ml COLD WATER + 25 ml puly Capucino™ system Yellow CLEANER</p> <p>OPERATE THE CAPPUCCINO MAKER</p>	<p><b>1 - CLEANING</b></p>  <p>500 ml HOT WATER + 25 ml puly Capucino™ system Yellow CLEANER</p> <p>WAIT FOR AT LEAST 20 MINUTES</p>
 <p>RINSE WITH 1 LITRE OF COLD WATER</p> <p>OPERATE THE CAPPUCCINO MAKER</p>	 <p>RINSE WITH RUNNING WATER</p>
<p><b>2 - HYGIENIZING</b></p>  <p>500 ml COLD WATER + 25 ml puly Capucino™ system Azure HYGIENIZER</p> <p>OPERATE THE CAPPUCCINO MAKER</p>	<p><b>2 - HYGIENIZING</b></p>  <p>500 ml COLD WATER + 25 ml puly Capucino™ system Azure HYGIENIZER</p> <p>WAIT FOR AT LEAST 20 MINUTES</p>
<p>RINSE WITH POTABLE WATER</p>  <p>LEAVE TO DRY IN OPEN AIR</p>	<p>RINSE WITH POTABLE WATER</p>  <p>LEAVE TO DRY IN OPEN AIR</p>

-  Detergenti
-  Detergents
-  Reinigungsmittel
-  Detergentes



1092505



1092506



1092510



1092511



1092500



1092532



1092540



1092531



1092530

LF Code	Description	Notes
1092505	DETERGENT CAFIZA2	900 g
1092506	DETERGENT CAFIZA	566 g
1092510	DETERGENT CAFIZA	100 TABS 2.0 g each
1092511	DETERGENT CAFIZA	100 TABS 1.2 g each
1092500	DETERGENT CAFIZA2	28 g
1092532	SCALE REMOVER DEZCAL	900 g
1092540	SCALE REMOVER DEZCAL	1 L
1092531	SCALE REMOVER DEZCAL	200 g
1092530	SCALE REMOVER DEZCAL	25 g



1092520



1092521



1092522



1092545



1092003

LF Code	Description	Notes
1092520	DETERGENT RINZA CAPPUCCINATORE	1 L
1092521	DETERGENT RINZA CAPPUCCINATORE	1 L
1092522	DETERGENT RINZA CAPPUCCINATORE	40 TABS 10 g each
1092545	DETERGENT GRINDZ	430 g
1092003	DETERGENT CAFE SPRAYZ	450 ml



1092014







1092501







2106235

LF Code	Description	Notes
1092014	DETERGENT VENDZ	1 L
1092501	DETERGENT CUPZ	500 g
2106235	CAFE WIPZ	100 pcs

-  Detergenti
-  Detergents
-  Reinigungsmittel
-  Detergentes

caffenu®



-  per MACCHINE TIPO
-  for MACHINES
-  für MASCHINEN
-  para MAQUINAS

GAGGIA • LAVAZZA • PAVONI • SGL • MITACA • GRIMAC • RDL • SAECO • SPINEL ecc.



## 1092013

 **DECALCIFICANTE  
CAFFENU 200 ml**

elimina i residui di calcare dall'impianto idraulico e dalle caldaie delle macchine caffè tipo domestico, formula concentrata e rapida, non macchia e non tinge

 **CAFFENU DESCALER  
200 ml**

removes scale residues from the hydraulic system and coffee machines boilers household type, concentrated and fast formula, non-staining

 **ENTKALKER CAFFENU  
200 ml**

Entfernt Kalkablagerungen von Hydraulikteilen und Kochkesseln von Haushalt-Kaffeemaschinen, konzentrierte und schnell wirkende Formel hinterlässt keine Flecken

 **DESCALCIFICANTE  
CAFFENU 200 ml**

elimina los residuos calizos del sistema hidráulico y de las calderas de las maquinas café tipo doméstico, formula concentrada y rápida, no mancha

## 1092016

 **DECALCIFICANTE  
CAFFENU 200 ml 9 PZ**

elimina i residui di calcare dall'impianto idraulico e dalle caldaie delle macchine caffè tipo domestico, formula concentrata e rapida, non macchia e non tinge

 **CAFFENU DESCALER  
200 ml 9 PCS**

removes scale residues from the hydraulic system and coffee machines boilers household type, concentrated and fast formula, non-staining

 **ENTKALKER CAFFENU  
200 ml 9 STK**

Entfernt Kalkablagerung von der Hydraulik und von Kaffeemaschinen-Kochkessel Haushalt, Formel konzentriert und rasch, nicht befleckend



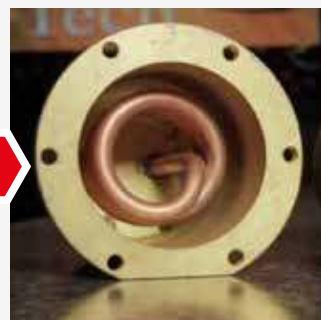

 **DESCALCIFICANTE  
CAFFENU 200 ml 9 UDS**

elimina los residuos calizos del sistema hidráulico y de las calderas de las maquinas café. tipo doméstico, formula concentrada y rápida, no mancha



LF Code	Description	Notes	Suitable for
1092013	DISINCROSTANTE CAFFENU	200 ml	ALL BRANDS - TUTTE LE MARCHE
1092016	DISINCROSTANTE CAFFENU	9x200 ml	ALL BRANDS - TUTTE LE MARCHE



-  Detergenti
-  Detergents
-  Reinigungsmittel
-  Detergentes

caffenu®



## 1092011

 **DETERGENTE IN CAPSULE CAFFENU**

compatibile con macchine NESPRESSO® per la pulizia del gruppo di erogazione, della doccetta e del beccuccio confezione 5 capsule da 3g

 **REINIGUNGSKAPSELN CAFFENU**

passend für alle NESPRESSO® Kapselautomaten für die hygienische Reinigung der Auslaufgruppe, Dusche und Düse Verpackung 5 Kapseln - 3g/jede

 **CLEANING CAPSULES CAFFENU**

compatible with NESPRESSO® machines for the cleaning of brew groups, shower screen and spout package with 5 capsules - 3g each

 **DETERGENTE CÁPSULAS CAFFENU**

compatible para máquinas NESPRESSO® para limpiar el grupo salida, duchas y salida café envase 5 cápsulas - 3g/cada

 Le Capsule detergenti Nespresso® Caffenu® sono compatibili con tutte le macchine Nespresso® alla data di produzione Giugno 2018:

 The Nespresso® Caffenu® cleaning capsules are compatible with all Nespresso® machines at the manufacturing date of June 2018:

**Le Cube • Essenza • K-mix • Krups • Delonghi Lattissima • Delonghi Lattissima Touch • Delonghi Lattissima Pro • Pixie • U • U Milk • Inissia • Maestria • Grand Maestria**

Il detergente in capsule Caffenu® funziona anche per qualsiasi macchina compatibile Nespresso®, così come su tutte le macchine che possono utilizzare sia la gamma di capsule Nespresso® Grand Cru o capsule alternative progettate per questo sistema.

The Caffenu® Cleaning Capsule will work in any Nespresso® compatible machine, as well as any machine that can use either Nespresso® Grand Cru range of capsules or any alternative capsule designed for this system.

**IMPORTANTE:** Questa capsula non è progettata per il sistema a capsule Nespresso® Vertuoline, e non è stata testata per le macchine da caffè a incasso e compatte Miele®.

**IMPORTANT:** This capsule is not designed for the Nespresso® Vertuoline capsule system, and has not been tested in the Miele® built in and free standing machines.



## 1092012

 **DETERGENTE IN CAPSULE CAFFENU 10 PZ**

compatibile con macchine NESPRESSO® per la pulizia del gruppo di erogazione, della doccetta e del beccuccio 10 confezioni da 5 capsule da 3g

 **REINIGUNGSKAPSELN CAFFENU 10 STK**

passend für alle NESPRESSO® Kapselautomaten für die hygienische Reinigung der Auslaufgruppe, Dusche und Düse 10 Verpackungen von 5 Kapseln - 3g/jede

 **CLEANING CAPSULES CAFFENU 10 PCS**

compatible with NESPRESSO® machines for the cleaning of brew groups, shower screen and spout 10 packages of 5 capsules - 3g each

 **DETERGENTE CÁPSULAS CAFFENU 10 UDS**

compatible para máquinas NESPRESSO® para la limpieza del grupo de erogación, de la ducha y de la salida 10 envases con 5 cápsulas - 3g/cada

 Die Nespresso® Caffenu® Reinigungskapseln sind kompatibel mit allen Nespresso® Maschinen mit Produktionsdatum bis Juni 2018:

 Las cápsulas de detergente Nespresso® Caffenu® son compatibles con todas las máquinas Nespresso® fabricadas hasta junio de 2018:





Die Caffenu® Reinigungskapseln Nespresso® funktionieren mit jeder kompatiblen Nespresso® Maschine, sowie mit allen Maschinen, die Nespresso® Kapseln Grand Cru oder alternative Kapseln benutzen.

El detergente en cápsulas Caffenu® también funciona para cualquier máquina compatible de Nespresso®, así como en todas las máquinas que pueden utilizar la gama de cápsulas Nespresso® Grand Cru o cápsulas alternativas diseñadas para este sistema.

**WICHTIG:** Diese Kapsel ist nicht für das Kapselsystem Nespresso® Vertuoline entworfen und wurde für kompakte oder Einbau-Kaffeemaschinen Miele® nicht getestet.

**¡IMPORTANTE!** Esta cápsula no está diseñada para el sistema de cápsulas Nespresso® Vertuoline, y no ha sido probado para máquinas de café Miele®.

LF Code	Description	Notes	Suitable for
1092011	CLEANING CAPSULES CAFFENU	5 CAPS 3 g each	NESPRESSO®
1092012	CLEANING CAPSULES CAFFENU	10x5 CAPS 3 g each	NESPRESSO®

-  Detergenti
-  Detergents
-  Reinigungsmittel
-  Detergentes

caffenu®



**1092024**

 **DETERGENTE IN CAPSULE  
CAFFENU MULTIPOD**

compatibile con macchine CAFFITALY®, K-FEE®, VERISMO®, EXPRESSI®, TCHIBO® CAFISSIMO®  
per la pulizia del gruppo di erogazione, della doccetta e del beccuccio  
confezione 4 capsule da 3g

 **CLEANING CAPSULES  
CAFFENU MULTIPOD**

compatible with machines CAFFITALY®, K-FEE®, VERISMO®, EXPRESSI®, TCHIBO® CAFISSIMO®  
for the cleaning of brew groups, shower screen and spout  
package with 4 capsules - 3g each

 **REINIGUNGSKAPSELN  
CAFFENU MULTIPOD**

passend für Kapselautomaten CAFFITALY®, K-FEE®, VERISMO®, EXPRESSI®, TCHIBO® CAFISSIMO®  
für die hygienische Reinigung der Auslaufgruppe, Dusche und Düse  
Verpackung 4 Kapseln - 3g/jede

 **DETERGENTE CÁPSULAS  
CAFFENU MULTIPOD**

compatible para máquinas CAFFITALY®, K-FEE®, VERISMO®, EXPRESSI®, TCHIBO® CAFISSIMO®,  
per la pulizia del gruppo di erogazione, della doccetta e del beccuccio  
envase 4 cápsulas - 3g/cada

**1092025**

 **DETERGENTE IN CAPSULE  
CAFFENU 10 PZ**

compatibile con macchine CAFFITALY®, K-FEE®, VERISMO®, EXPRESSI®, TCHIBO® CAFISSIMO®  
per la pulizia del gruppo di erogazione, della doccetta e del beccuccio  
10 confezioni da 4 capsule da 3g

 **CLEANING CAPSULES  
CAFFENU 10 PCS**

compatible with machines CAFFITALY®, K-FEE®, VERISMO®, EXPRESSI®, TCHIBO® CAFISSIMO®  
for the cleaning of brew groups, shower screen and spout  
10 packages of 4 capsules - 3g each

 **REINIGUNGSKAPSELN  
CAFFENU 10 STK**

passend für Kapselautomaten CAFFITALY®, K-FEE®, VERISMO®, EXPRESSI®, TCHIBO® CAFISSIMO®  
für die hygienische Reinigung der Auslaufgruppe, Dusche und Düse  
10 Verpackungen von 4 Kapseln - 3g/jede

 **DETERGENTE CÁPSULAS  
CAFFENU 10 UDS**





compatible para máquinas CAFFITALY®, K-FEE®, VERISMO®, EXPRESSI®, TCHIBO® CAFISSIMO®  
para limpiar el grupo salida, duchas y salida café  
10 envases con 4 cápsulas - 3g/cada



*These coffee machines are not for sale*

Caffitaly® • K-Fee® • Verismo® • Expressi® • Tchibo® Cafissimo®

LF Code	Description	Notes	Suitable for
1092024	CLEANING CAPSULES MULTIPOD	4 CAPS 3 g	CAFFITALY® - K-FEE® - VERISMO® - EXPRESSI® - TCHIBO® - CAFISSIMO®
1092025	CLEANING CAPSULES MULTIPOD	10x4 CAPS 3 g	CAFFITALY® - K-FEE® - VERISMO® - EXPRESSI® - TCHIBO® - CAFISSIMO®

-  Detergenti
-  Detergents
-  Reinigungsmittel
-  Detergentes

caffenu®



**1092026**

 **DETERGENTE IN CAPSULE  
CAFFENU A MODO MIO**

compatibile con macchine LAVAZZA A MODO MIO®  
per la pulizia del gruppo di erogazione,  
della doccetta e del beccuccio  
confezione 4 capsule da 3g

 **CLEANING CAPSULES  
CAFFENU A MODO MIO**

compatible with machines LAVAZZA A MODO MIO®  
for the cleaning of brew groups,  
shower screen and spout  
package with 4 capsules - 3g each

 **REINIGUNGSKAPSELN  
CAFFENU A MODO MIO**

passend für Kapselautomaten LAVAZZA A MODO MIO®  
für die hygienische Reinigung der  
Auslaufgruppe, Dusche und Düse  
Verpackung 4 Kapseln - 3g/jede

 **DETERGENTE CÁPSULAS  
CAFFENU A MODO MIO**

compatible para máquinas LAVAZZA A MODO MIO®  
para limpiar el grupo salida, duchas y  
salida café  
envase 4 cápsulas - 3g/cada

**1092027**

 **DETERGENTE IN CAPSULE  
CAFFENU 10 Pz**

compatibile con macchine LAVAZZA A MODO MIO®  
per la pulizia del gruppo di erogazione,  
della doccetta e del beccuccio  
10 confezioni da 4 capsule da 3g

 **CLEANING CAPSULES  
CAFFENU 10 PCS**

compatible with machines LAVAZZA A MODO MIO®  
for the cleaning of brew groups,  
shower screen and spout  
10 packages of 4 capsules - 3g each

 **REINIGUNGSKAPSELN  
CAFFENU 10 STK**

passend für Kapselautomaten LAVAZZA A MODO MIO®  
für die hygienische Reinigung der  
Auslaufgruppe, Dusche und Düse  
10 Verpackungen von 4 Kapseln - 3g/jede

 **DETERGENTE CÁPSULAS  
CAFFENU 10 UDS**





compatible para máquinas LAVAZZA A MODO MIO®  
para limpiar el grupo salida, duchas y  
salida café  
10 envases con 4 cápsulas - 3g/cada



*These coffee machines are not for sale*

Lavazza A Modo Mio®

LF Code	Description	Notes	Suitable for
1092026	CLEANING CAPSULES A MODO MIO	4 CAPS 3 g	LAVAZZA A MODO MIO®
1092027	CLEANING CAPSULES A MODO MIO	10x4 CAPS 3 g	LAVAZZA A MODO MIO®

-  Detergenti
-  Detergents
-  Reinigungsmittel
-  Detergentes

## 3092263



### **SPUGNA MAGICA** **125x55x30 mm - 16 PZ**

detergente pulifunzionale  
ECOLOGICO-ANTIBATTERICO-ECONOMICO  
per tutte le superfici dure,  
quali acciaio, marmi ecc.  
riduce i batteri del 99,99%  
CONFEZIONE 16 pz



### **ZAUBERSCHWAMM** **125x55x30 mm - 16 STK.**

Mehrweckreinigungsmittel  
ÖKOLOGISCH-ANTIBAKTERIELL-GÜNSTIG  
für alle harte Oberflächen,  
wie Stahl, Marmore usw.  
entfernt 99,99% Bakterien  
VERPACKUNG 16 St.



### **MAGIC SPONGE** **125x55x30 mm - 16 PCS**

multifunction detergent  
ECO-FRIENDLY - ANTIBACTERIAL - CHEAP  
for all hard surfaces,  
such as steel, marble, etc.  
it reduces 99.99% of bacteria  
16 pcs PACKAGE



### **ESPONJA MÁGICA** **125x55x30 mm - 16 UDS**

detergente multi-función  
ECOLOGICO-ANTI-BACTERICO-ECONOMICO  
para todas las superficies duras,  
como acero inox, mármoles, etc.  
reduce las bacterias del 99,99%  
PAQUETE 16 uds.



## 3092260



### **MAGIC STONE** **CONFEZIONE DA 15 PZ**

dimensioni 100x70x45 mm  
100% vetro - 580°C  
DIN 53420-UNI 53215  
abrasivo per sporco e calcare  
per griglie, piani cottura, teglie,  
pentole, padelle, forni, ecc



### **MAGIC STONE** **PACKUNG 15 STK.**

Maße 100x70x45 mm  
100% Glas - 580°C  
DIN 53420-UNI 53215  
Scheuermittel für Schmutz und Kalksteine  
für Gitter, Kochfelder, Blechen,  
Kochkessel, Pfannen, Öfen, usw.



### **MAGIC STONE** **15 PCS PACKAGE**





dimensions 100x70x45 mm  
100% glass - 580°C  
DIN 53420-UNI 53215  
abrasive against dirt and limescale  
for gills, pot stoves, baking trays,  
pans, frying pans, ovens, etc.



### **MAGIC STONE** **ENVASE 15 UDS.**

medidas 100x70x45 mm  
100% cristal - 580°C  
DIN 53420-UNI 53215  
abrasivo para suciedad y cal  
para rejillas, cocina sobremesas,  
bandejas marmitas, sartenes, hornos, etc.



-  Detergenti
-  Detergents
-  Reinigungsmittel
-  Detergentes

## 3092335



 **PANNO MICROFIBRA VETRI BARISTAPRO**

dimensioni 400x400 mm  
per la pulizia ecologica di vetri,  
cristalli, bicchieri e specchi

 **CLOTH MICROFIBRE GLASS BARISTAPRO**

dimensions 400x400 mm  
for ecological cleaning of panes,  
windows, glasses and mirrors

 **MIKROFASERTUCH GLAS BARISTAPRO**

Maße 400x400 mm  
zur ökolog. Reinigung von Gläser,  
Kristalle, Trinkgläser und Spiegel

 **PAÑO MICROFIBRA VIDRIO BARISTAPRO**

dimensiones 400x400 mm  
para la limpieza ecologica de vidrios,  
cristales, vasos y espejos



## 3092336

 **PANNO MICROFIBRA MULTIUSO BARISTAPRO**

testato antibatterico  
dimensioni 400x400 mm  
pulisce e igienizza tutte le superfici  
senza detersivi

 **CLOTH MICROFIBRE MULTIPURP. BARISTAPRO**

antibacterial tested  
dimensions 400x400 mm  
it cleans and sanitizes all surfaces  
without the use of detergents

 **MIKROFASERTUCH MEHRZWECK BARISTAPRO**

antibakteriell geprüft  
Maße 400x400 mm  
reinigt und desinfiziert alle  
Oberflächen ohne Reinigungsmittel

 **PAÑO MICROFIBRA MULTIUSO BARISTAPRO**

probado antibacteriano  
dimensiones 400x400 mm  
limpia y desinfecta todas las  
superficies sin detergentes





## Il primo passo per un **espresso perfetto:**

Docce e filtri progettati per ottenere la perfetta estrazione ed esaltare l'aroma del caffè  
...per chi cerca l'eccellenza!



## Der erste Schritt zum **perfekten Espresso:**

Duschen und Siebe zur idealen Extraktion und zur Aromaoptimierung  
...für alle die, die perfekte Leistungen erwarten!



## The first step to make a **perfect espresso:**

Precision showers and filters designed to ensure the ideal extraction and to enhance the aroma of coffee  
...for those wanting the best in their performance!



## El primer paso para un **espresso perfecto:**

Duchas y filtros proyectados para obtener la perfecta extracción y exaltar el aroma del café  
...¡para quien quiere la excelencia absoluta!

**Per le macchine caffè delle migliori marche**  
For coffee machines by the best brands  
Für alle führenden Maschinenhersteller  
Para máquinas de café de las mejores marcas

**MMS**  
COMPETITION SERIES

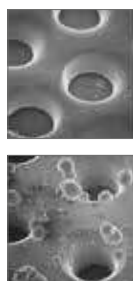
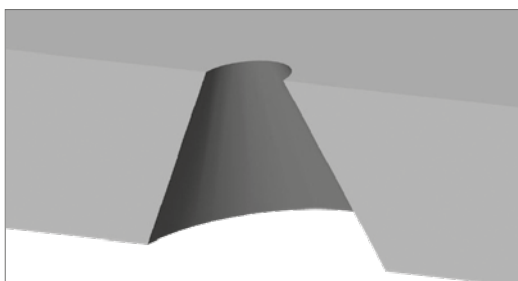

### **Fori circolari in forma conica**

- migliore erogazione del caffè grazie ai fori conici
- superficie temprata e resistente all'usura, con conseguente maggiore durata di vita



### **Circular holes with conical cross section**

- enhanced coffee outpouring due to the conical holes
- electro-polished resistant surface, assuring extended life-time



### **Exakt runde Löcher mit konischer Führung**

- verbesserter Kaffeeauslauf durch konische Löcher
- hochglanzpoliert, verlängerte Lebensdauer



### **Agujeros circulares en forma cónica**

- mejor erogación del café gracias a los agujeros cónicos
- superficie templada y resistente al desgaste, con la consiguiente mayor duración de vida



### **Finitura a specchio**

- lucidatura a specchio per ridurre drasticamente i residui di caffè, anche nei fori conici



### **Mirror polishing**

- the finish significantly reduces adherents of dirt and coffee residuals, even in the conical holes



### **Hochglanzpoliert**

- diese Behandlung reduziert die Ablagerung von Schmutz und Kaffeeresten deutlich



### **Acabado en espejo**

- acabado en espejo para reducir drásticamente los residuos de café, también en los agujeros cónicos



**Erogazione controllata e uniforme per esaltare le qualità del caffè, ottenendo una crema vellutata e delicata**

Precise and evenly outpouring to enhance coffee features, obtaining a velvety and delicate cream

Präziser und gleichmäßiger Auslauf um die Kaffeequalität zu erhöhen und eine perfekte Crema zu erreichen

Erogación controlada y uniforme para exaltar la calidad del café, obteniendo una crema aterciopelada y delicada



**Docce con speciale e innovativa membrana (integrata o tessuta) per un'ottima distribuzione dell'acqua sulla polvere di caffè**

La doccia a MEMBRANA TESSUTA I.M.S. ha un passaggio di 35 µm e la sua caratteristica principale è l'elevato potere filtrante che garantisce una distribuzione omogenea dell'acqua sulla pastiglia di caffè, blocca il passaggio dei residui di estrazione migliorando la fase di asciugatura.

Questo permette di mantenere il gruppo pulito e perfettamente efficiente, inoltre preserva sia gruppo che elettrovalvola dall'usura causata dallo sporco.

La doccia con MEMBRANA INTEGRATA studiata da I.M.S. è costituita da una speciale membrana che viene formata all'interno del corpo di supporto della doccia e ha un filtraggio di 200 µm.

La sua caratteristica principale è l'esclusivo design di foratura che, oltre a garantire la miglior erogazione possibile, rende questo prodotto estremamente resistente e facile da pulire. Infatti essendo realizzata in un pezzo unico il corpo è irrobustito e la superficie è totalmente liscia, quindi priva di zone nocive in cui si possa fermare lo sporco.



**Duschen mit spezieller und innovativer Membrane (integriert oder verdrahtet) für eine ideale Wasser Verteilung über dem ganzen Kaffeepulver.**

Die I.M.S. VERDRAHTETE MEMBRANE hat eine Filterleistung von 35 µm; ihr Hauptmerkmal ist eine erhöhte Filterkapazität die eine gleichmäßige Wasserverteilung über die gesamte Kaffee kapsel gewährleistet, den Durchlauf von extraktions Resten blockiert und verbessert so die Trocknungsphase.

Auf diese Weise bleibt die Gruppe sauber und vollkommen effizient. Es bewahrt auch die Gruppe und das Magnetventil vor von Schmutz verursachtem Verschleiß.

Die von I.M.S. entworfene INTEGRIERTE MEMBRANE besteht aus einer im Inneren des Stützkörpers der Dusche eingebauten speziellen Membrane und verfügt über eine Filterkapazität von 200 µm.

Das Hauptmerkmal dieses Produkts ist das einzigartige Perforations Design, dass nicht nur die bestmögliche Kaffeequalität gewährleistet, sondern dieses Produkt auch extrem langlebig und leicht zu reinigen macht. Dar es aus einem einzigen Stück hergestellt wird, ist der Körper gestärkt und die Oberfläche völlig glatt und es verhindert somit jegliche schädliche Ablagerungsmöglichkeiten.



**Showers with special and innovative membrane (integrated or wired) in allowing ideal water distribution throughout on the coffee powder**

The I.M.S. WIRE MEMBRANE SHOWER SCREEN has a filtering power of 35 µm and its main feature is an elevated filtering capacity which, as well as ensuring an even water distribution throughout the coffee puck, also blocks access to the extract residues thereby improving the drying phase.

This allows the group to be kept clean and perfectly efficient. It also preserves both the group and the solenoid valve from wear caused by dirt.

The INTEGRATED MEMBRANE SHOWER SCREEN designed by I.M.S. consists of a special membrane built inside the supporting body of the shower and has a filtering capacity of 200 µm.

The key feature of this product is the unique perforation design which, in addition to ensuring the best possible coffee, makes this product extremely durable and easy to clean. Manufactured as a single piece, the body is strengthened and the surface is completely smooth, and thus does not present any grind-clogging danger areas.







**Duchas con especial e innovadora membrana (integrada o tejida) para una óptima distribución del agua sobre los polvos de café**

La ducha con MEMBRANA TEJIDA I.M.S tiene un pasaje de 35µm, su característica principal es su elevado poder filtrador que garantiza una distribución homogénea del agua sobre la pastilla de café, bloquea el pasaje de los residuos de extracción mejorando la fase de secado.

Esto permite mantener grupo limpio y completamente eficiente, además de preservar también el grupo como la electroválvula del uso causado por la suciedad.

La ducha con MEMBRANA INTEGRADA diseñada por I.M.S está constituida por una membrana especial creada en el interior del cuerpo del soporte de la ducha y tiene una filtración de 200 µm.

Su característica principal es el diseño exclusivo de perforación que, además de garantizar la mejor salida posible, hace este producto extremadamente resistente y fácil que limpiar. De hecho, siendo realizada por una única pieza el cuerpo es endurecido y la superficie es totalmente lisa, por lo tanto, elimina zonas nocivas que puedan acumular la suciedad.

-  Docce erogazione gruppo caffè
-  Shower screens for brew group
-  Auslaufduschen für Kaffeegruppen
-  Duchas erogación grupo café



Astoria/Cma - Bezzera - Bfc - Brasilia - Carimali - Casadio - Cimballi - Ecm  
Elektra - Faema - Fiorenzato Cs - Fracino - Grimac - Reneka - Royal - Sab Italia  
Sanremo - Scala - Victoria Arduino - Wega

Azkoyen - Bezzera - Bfc - Bianchi - Brasilia - Casadio - Ecm - Ecm Manufacture  
Expobar - Faema - Faimac - Fiamma Rst - Fiorenzato Cs - Futurmat  
Gaggia Spagna - Grimac - Italcrem - Mairali - Orchestrale - Promac - Reneka  
Royal - Sab Italia - Sanremo - Scala - Vfa - Vibiemme - Victoria Arduino  
Visacrem - Wega - **E61 Groups**



integrated membrane 200 µm

**1460200**

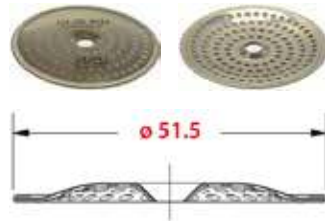

wire membrane 35 µm

**1460205**



integrated membrane 200 µm

**1460201**



wire membrane 35 µm

**1460206**

Carimali - Marzocco - Slayer - Synesso

Brugnetti Aurora - Nuova Simonelli - Victoria Arduino

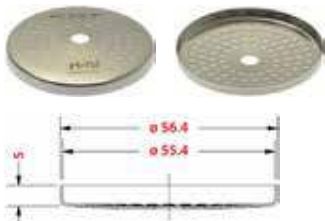

integrated membrane 200 µm

**1460202**



wire membrane 35 µm

**1460207**



integrated membrane 200 µm

**1460204**



wire membrane 35 µm

**1460209**

Bezzera - Magister - Pavoni - Promac - Rancilio

Astoria/Cma - San Marco - Wega

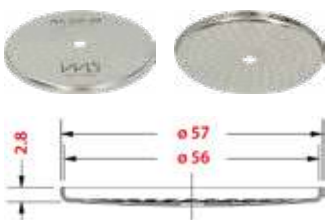

integrated membrane 200 µm

**1460203**

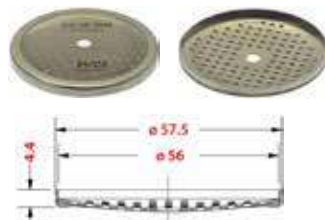

wire membrane 35 µm

**1460208**



integrated membrane 200 µm

**1460210**

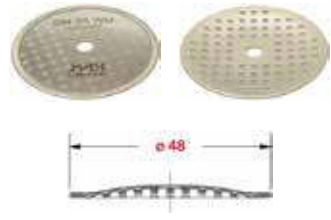

wire membrane 35 µm

**1460212**

Dalla Corte - Spaziale

Gaggia - Saeco



integrated membrane 200 µm

**1460211**

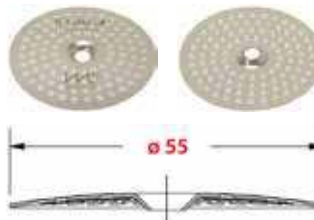

membrana integrata 200 µm



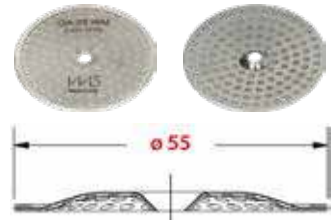

**1081103**



membrane woven 35 µm

**1081099**



-  Docce erogazione gruppo caffè
-  Shower screens for brew group
-  Auslaufduschen für Kaffeegruppen
-  Duchas erogación grupo café



### Nanotech

San Marco Leva

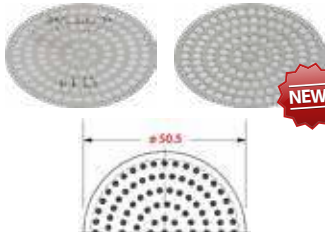

integrated membrane 200 µm

1081121

Astoria/Cma - Bezzera - Bfc - Brasilia - Carimali - Casadio - Cimbali - Elektra  
Faema - Fiorenzato Cs - Fracino - Grimac - Reneka - Royal - Sab Italia  
Sanremo - Scala - Victoria Arduino - Wega

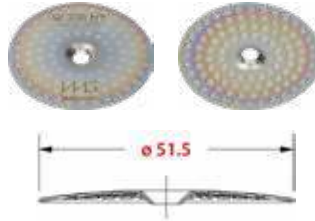

integrated membrane 200 µm

1081600

### Nanotech

Nuova Simonelli - Rancilio

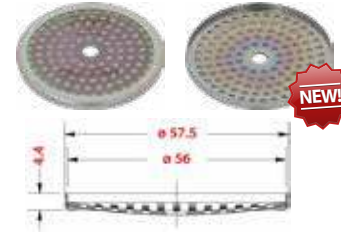

photoengraved membrane 200 µm  
reinforced model

1081126

### Nanotech

Carimali - Marzocco - Slayer  
Synesso

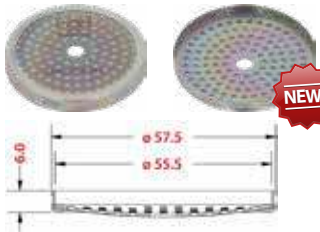

photoengraved membrane 200 µm  
reinforced model

1081122

### Nanotech

Bezzera - Magister - Pavoni  
Promac - Rancilio



integrated membrane 200 µm

1081602

### Nanotech

Dalla Corte - Spaziale



integrated membrane 200 µm

1081119

### Nanotech

Astoria/Cma - San Marco - Wega

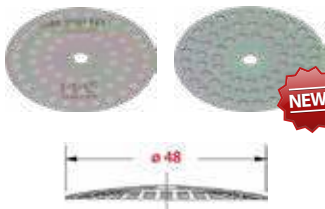

integrated membrane 200 µm

1081118

### Nanotech

Brugnetti Aurora - Nuova Simonelli  
Victoria Arduino

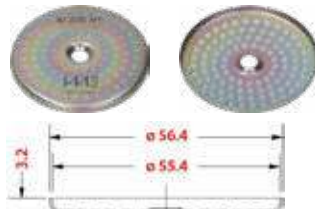

integrated membrane 200 µm

1081603

### Nanotech

Gaggia - Saeco

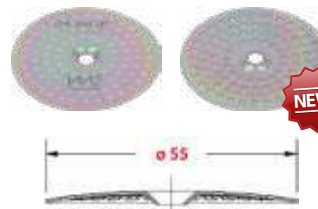

integrated membrane 200 µm

1081120

### Nanotech

Marzocco - Slayer - Synesso



integrated membrane 200 µm

1081604

### Nanotech

### Nanotech

Azkoyen - Bezzera - Bfc - Bianchi - Brasilia - Casadio - Ecm - Ecm Manufacture - Expobar - Faema - Faimac - Fiamma Rst - Fiorenzato Cs - Futurmat - Gaggia Spagna  
Grimac - Italcrem - Mairali - Orchestrale - Promac - Reneka - Royal - Sab Italia - Sanremo - Scala - Vfa - Vibiemme - Victoria Arduino - Visacrem - Wega - **E61 Groups**



integrated membrane 200 µm

1081601



photoengraved membrane 200 µm  
reinforced model

1081123

## Curved-edge technology

Astoria - Casadio - Conti - Elektra - Fracino - Keesvanderwesten - Magister - Marzocco - N.simonelli - Pavoni - Promac - Rancilio - Slayer - Synesso - Victoria Arduino  
**E61 Groups**



1460100



1460101



1460102



1460103

Carimali - Cimbali - Gaggia - Reneka

**E61 Groups**



1460105



1460106



1460107



1460104

Dallacorte - Gruppoizzo - Sanmarco

Astoriaplus4you - Wegaconcept



1460108



1460109



1460115



1460112

Astoriaplus4you - Wegaconcept - Spaziale

Sanremo Opera - **E61 Groups**



1460110



1460111

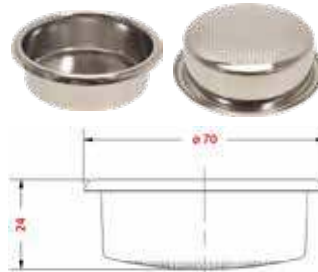

1460113



1460114





LF Code	Cups no.	Capacity (g)	Filter edge ø	Filter body ø	Filter height
1460100	1	6/8	70 mm	60 mm	24.5 mm
1460101	1	7/9	70 mm	60 mm	26.5 mm
1460102	2	12/18	70 mm	60 mm	24.5 mm
1460103	2	14/20	70 mm	60 mm	26.5 mm
1460104	2	18/22	70 mm	60 mm	28.5 mm
1460105	1	6/9	68 mm	60 mm	24.5 mm
1460106	2	12/18	68 mm	60 mm	24.5 mm
1460107	2	16/22	68 mm	60 mm	26.5 mm
1460108	1	6/8	66 mm	56 mm	25 mm
1460109	2	12/18	66 mm	56 mm	26 mm
1460110	1	6/8	65 mm	55 mm	25 mm
1460111	2	12/18	65 mm	55 mm	27.5 mm
1460112	3	21	65 mm	55 mm	32 mm
1460113	2	12/18	70 mm	60 mm	24.5 mm
1460114	2	14/20	70 mm	60 mm	26.5 mm
1460115	2	18/20	66 mm	56 mm	32 mm

## ultrafine model

Astoria - Casadio - Conti - Elektra - Fracino - Keesvanderwesten - Magister - Marzocco - N.Simonelli - Pavoni - Promac - Rancilio - Slayer - Synesso - Victoria Arduino  
E61 Groups



LF Code	Cups no.	Capacity (g)	Filter height	Holes no.	Membrane
1460400	2	12/18	24 mm	565	170 µm
1460401	2	14/20	26 mm	565	170 µm
1460402	2	18/22	26 mm	565	170 µm

-  Filtri caffè
-  Coffee filters
-  Kaffeefilter für Siebträger
-  Filtros café



## Filtri Baristapro

Ecco le principali peculiarità dei filtri della nuova linea Baristapro

### 1. Caratteristiche dei fori:

- foratura originale ed esclusiva LF
- perforazione perfettamente circolare per consentire un passaggio **equilibrato** dell'acqua e una migliore estrazione e quindi una crema ed un corpo migliori
- realizzati con un **diametro ed un numero preciso specificamente studiato e testato** per garantire un'estrazione omogenea ed una quantità equilibrata di solubili in tazza
- staccati dal bordo del filtro e distribuiti verso il centro, **per eliminare il channeling**

### 2. 100% made in Italy

### 3. Elettrolucidatura, per garantire una superficie a maggior resistenza e durata

La linea BARISTAPRO comprende un filtro doppio e uno singolo. Il BARISTAPRO da una tazza S ha una foratura modificata, con aumento di fori del 90% per ottenere una maggior estrazione anche con caffè tostati leggeri.

Con i filtri BARISTAPRO S non sarà più necessario modificare i parametri del macinadosatore, quindi stessa macinatura e stessa pressatura.



## Baristapro Filter

Hier finden Sie die wichtigsten Merkmale der neuen Baristapro Filter Linie

### 1. Eigenschaften der Löcher:

- originelle und LF-exklusive Lochung
- perfekt kreisförmige Lochung, um einen **ausgeglichenem** Wasserdurchfluss zu ermöglichen und die Extraktion zu verbessern. Das Ergebnis ist eine bessere Crème und die perfekte Dichte
- Durchmesser und **Löcher Nummer sind spezifisch studiert und getestet**, um eine homogene Extraktion und eine ausgeglichene lösliche Menge zu garantieren
- sie sind vom Filterrand getrennt und in Richtung Mitte verteilt, um das **Channeling zu vermeiden**

### 2. 100% made in Italy

### 3. Um eine widerstandsfähigere und dauerhaftere Oberfläche zu garantieren, wird das Produkt **elektropoliert**

Die BARISTAPRO Linie enthält sowohl Filter für 2-Tassen als auch für 1-Tasse. Der 1-Tasse BARISTAPRO S Filter hat eine modifizierte Lochung, mit einer Löcherzahl Erhöhung von 90%, um auch mit leicht geröstetem Kaffee eine intensivere Extraktion zu erzielen.

Mit den BARISTAPRO S Filter, ist es nicht mehr notwendig, die Parameter des Dosiermahlgerätes zu modifizieren. Einheitliches Mahlen und einheitliches Pressen.



## Baristapro filters

Here the main characteristics of the filters of the new Baristapro series

### 1. Holes characteristics:

- original perforation and exclusive to LF
- circular perforation which allows the water to pass in a **balanced** manner. This provides a better extraction therefore better 'Cream' and a full-bodied coffee
- made with an **exact diameter and number, specifically studied and tested** to ensure an homogeneous extraction and a balanced soluble quantity in the cup
- distanced from the filter Edges and distributed towards the middle, in order to **eliminate channelling**

### 2. 100% made in Italy

### 3. Electro-polishing, to guarantee a stronger and more durable surface

The BARISTAPRO series includes a double and single basket. The perforation on the 1-cup BARISTAPRO S has been modified, with a hole increase of 90%. This allows for better extraction, even on lightly roasted coffees.

With the BARISTAPRO S filters isn't necessary to modify the parameters of the coffee grinder doser, so same grinding and same pressing.



## Filtros Baristapro

Las principales peculiaridades de los filtros de la nueva línea Baristapro

### 1. Características de los agujeros:

- punción original y exclusiva LF
- perforación perfectamente circular para permitir el paso **equilibrado** del agua y una mejor extracción, lo que permite obtener una crema y un cuerpo aún mejor
- realizados con un **diámetro y un número preciso específicamente estudiado y testeado**, para garantizar una extracción homogénea y una cantidad equilibrada de soluble en tasa
- separados del borde del filtro y distribuido hacia el centro, **para eliminar la canalización**

### 2. 100% made in Italy

### 3. Electro pulido, para garantizar una superficie con mayor resistencia y duración

La línea BARISTAPRO comprende ya sea filtros de dos tasas como de una. El BARISTAPRO de una tasa S tiene una perforación modificada, con un aumento de las perforaciones del 90% para obtener una mayor extracción incluso con el café tostado claro.

Con los filtros BARISTAPRO S no será más necesario modificar los parámetros del molino dosificador, entonces el mismo molido y misma prensa.





## Straight-edge technology

Astoria - Azkoyen - Bezzera - Brasilia - Carimali - Conti - ECM - Elektra - Expobar - Faema - Florenzato - Futurmat - Gaggia - Grimac - Isomac - La Scala - Nuova Simonelli - Rancilio - Synesso - VFA - Wega  
and all the filter holders  $\varnothing$  57 mm and 58 mm



1460017



1460020



1460021

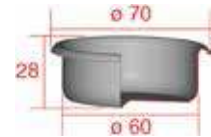

1460027

Nanotech



1460018

Nanotech



1460022

Nanotech



1460023

Nanotech

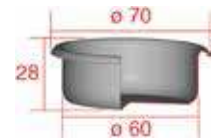

1460024



1460019







1460025



1460026



LF Code	Cups no.	Capacity (g)	Filter edge $\varnothing$	Filter body $\varnothing$	Filter height	Notes
1460017	2	15	70 mm	60 mm	22 mm	
1460020	2	18	70 mm	60 mm	24 mm	
1460021	2	20	70 mm	60 mm	26 mm	
1460027	2	21+	70 mm	60 mm	28 mm	
1460018	2	15	70 mm	60 mm	22 mm	Nanotech
1460022	2	18	70 mm	60 mm	24 mm	Nanotech
1460023	2	20	70 mm	60 mm	26 mm	Nanotech
1460024	2	21+	70 mm	60 mm	28 mm	Nanotech
1460019	1	7 - 8,5	70 mm	60 mm	21 mm	
1460025	1	8,5 - 10	70 mm	60 mm	22,5 mm	
1460026	1	10 - 12	70 mm	60 mm	24 mm	

-  Filtri caffè
-  Coffee filters
-  Kaffeesiebe für Siebträger
-  Filtros café

## The Single



LF Code	Cups no.	Capacity (g)	Filter edge ø	Filter height
1460307	1	10,5	68 mm	23 mm
1460302	1	12	70 mm	22,5 mm
1460301	1	9,5	70 mm	21 mm
1460300	1	7,5	70	19,5 mm

## Adapter filter for EP capsules



Photo	LF Code	Suitable for	Capsule	AxBxH	Notes
1	1160104	ASTORIA CMA - WEGA (52 mm)	SINGLE	65x55x64	---
1	1160600	BEZZERA - BRASILIA - EXPOBAR - FAEMA - FIORENTATO CS - GAGGIA - GRIMAC	SINGLE	70x60x68	---
1	1160600	MARZOCCO - RANCILIO - SAB ITALIA - SANREMO - SCALA - VIBIEMME - WEGA	SINGLE	70x60x68	---
1	1160605	CIMBALI	SINGLE	68x60x65	---
1	1160607	RANCILIO	SINGLE	70x60x65	---
1	1160108	SAN MARCO - DALLA CORTE	SINGLE	66x56x62	---
1	1160105	SAN MARCO	SINGLE	65.5x56x68	LEVA
1	1160615	SPAZIALE	SINGLE	65x55x64	---
2	1460045	ASTORIA CMA - WEGA (52 mm)	SINGLE	65x55x75	SUPER CREAM
2	1460046	SAN MARCO	SINGLE	66x57x73	SUPER CREAM
2	1460047	SPAZIALE	SINGLE	65x55x78	SUPER CREAM
2	5064969	BFC - BIANCHI - BRASILIA - CONTI - EXPOBAR - FAEMA - FIORENTATO CS	SINGLE	70x60x75	SUPER CREAM
2	5064969	FUTURMAT - GRIMAC - ROYAL - SAB ITALIA - SANREMO - VIBIEMME - WEGA	SINGLE	70x60x75	SUPER CREAM
2	5071383	ASTORIA - BEZZERA - BRASILIA - CIMBALI - MARZOCCO - NUOVA SIMONELLI	SINGLE	70x60x75	SUPER CREAM
2	5071383	PROMAC - RANCILIO - VICTORIA ARDUINO	SINGLE	70x60x75	SUPER CREAM
2	1460048	BFC - BIANCHI - BRASILIA - CONTI - EXPOBAR - FAEMA - FIORENTATO CS	DOUBLE	70x60x80	SUPER CREAM
2	1460048	FUTURMAT - GRIMAC - ROYAL - SAB ITALIA - SANREMO - VIBIEMME - WEGA	DOUBLE	70x60x80	SUPER CREAM
2	1460049	ASTORIA - BRASILIA - BEZZERA - MARZOCCO - NUOVA SIMONELLI	DOUBLE	70x60x80	SUPER CREAM
2	1460049	MAGISTER - PAVONI - RANCILIO	DOUBLE	70x60x80	SUPER CREAM



## 1486040

 **GUARNIZIONE PORTAFILTRO**  
**ø 73x57x8,5 mm**

Con spacchi interni.  
 Prodotta con silicone resistente al calore, di consistenza morbida per una più facile installazione sul gruppo. Maggiore durata, migliore tenuta ed ottima visibilità grazie al colore chiaro.

Adattabile per gruppi tipo E61  
 Adattabile per macchine AZKOYEN, BEZZERA, BIANCHI, EXPOBAR, FAEMA, SANREMO, VIBIEMME

 **FILTER HOLDER GASKET**  
**ø 73x57x8.5 mm**

With internal grooves.  
 Produced with heat-resistant silicone, soft consistency for an easier installation on the group. Longer durability, better sealing and excellent visibility thanks to its light colour.

Suitable for groups type E61  
 Suitable for machines AZKOYEN, BEZZERA, BIANCHI, EXPOBAR, FAEMA, SANREMO, VIBIEMME

 **SIEBTRÄGERDICHTUNG**  
**ø 73x57x8,5 mm**

Mit Innenrillen.  
 Aus wärmebeständigem Silikon gemacht, aus weichem Konsistenz für eine einfachere Installation auf der Gruppe.  
 Längere Laufzeit, bessere Dichtheit und optimale Sichtbarkeit dank seiner Hellfarbe.

Passend für Gruppen Sorte E61  
 Passend für Maschinen AZKOYEN, BEZZERA, BIANCHI, EXPOBAR, FAEMA, SANREMO, VIBIEMME

 **JUNTA PORTAFILTRO**  
**ø 73x57x8,5 mm**

Con huecos interiores  
 Producida con silicona resistente al calor, de consistencia suave para una instalación en el grupo más fácil.  
 Mayor duración, mejor estanqueidad y óptima visibilidad gracias a su color claro.

Adaptable para grupos tipo E61  
 Adaptable para maquinas AZKOYEN, BEZZERA, BIANCHI, EXPOBAR, FAEMA, SANREMO, VIBIEMME

## 1486042

 **GUARNIZIONE PORTAFILTRO**  
**ø 72x55x6,1/8 mm**

Conica  
 Con spacchi esterni.  
 Prodotta con silicone resistente al calore, di consistenza morbida per una più facile installazione sul gruppo. Maggiore durata, migliore tenuta ed ottima visibilità grazie al colore chiaro.

Adattabile per macchine MARZOCCO  
 Adattabile per macchine SYNESSO, SLAYER, MAVAM

 **FILTER HOLDER GASKET**  
**ø 72x55x6.1/8 mm**

Conical.  
 With external grooves produced with heat-resistant silicone, soft consistency for an easier installation on the group. Longer durability, better sealing and excellent visibility thanks to its light colour.

Suitable for machines MARZOCCO  
 Suitable for machines SYNESSO SLAYER, MAVAM

 **SIEBTRÄGERDICHTUNG**  
**ø 72x55x6,1/8 mm**

Kegelförmig.  
 Mit Aussenrillen.  
 Aus wärmebeständigem Silikon gemacht, aus weichem Konsistenz für eine einfachere Installation auf der Gruppe.  
 Längere Laufzeit, bessere Dichtheit und optimale Sichtbarkeit dank seiner Hellfarbe.

Passend für Maschinen MARZOCCO  
 Passend für Maschinen SYNESSO SLAYER, MAVAM



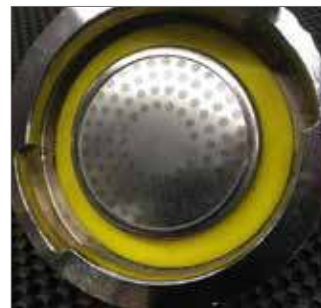

 **JUNTA PORTAFILTRO**  
**ø 72x55x6,1/8 mm**

Cónica.  
 Con huecos exteriores.  
 Producida con silicona resistente al calor, de consistencia suave para una instalación en el grupo más fácil.  
 Mayor duración, mejor estanqueidad y óptima visibilidad gracias a su color claro.

Adaptable para maquinas MARZOCCO  
 Adaptable para maquinas SYNESSO SLAYER, MAVAM



LF Code	Dimensions	Notes	Mechanical characteristics	Suitable for
1486040	ø 73x57x8,5 mm	WITH INTERNAL SPLITS CON SPACCHI INTERNI	LONGER DURABILITY BETTER SEALING	EXPOBAR - FAEMA - FUTURMAT SANREMO - VIBIEMME - & MORE
1486042	ø 72x55x6,1/8 mm	WITH INTERNAL SPLITS CON SPACCHI INTERNI	LONGER DURABILITY BETTER SEALING	MARZOCCO - SYNESSO - SLAYER MAVAM

-  Kit barista
-  Kit for barista
-  Barista KIT
-  Kit para barista



## 1950013



### **BARISTA KIT "ROMA"**

composto da:  
 1 lattiera Europa 0,75 L 1224011  
 1 lattiera Europa 0,50 L 1224010  
 1 spolveratore di cacao 1094003  
 1 termometro 1394554  
 1 pressino ø 58 mm 1385060  
 1 portapressino 1385023  
 1 penna latte art 1394006

### **BARISTA "ROMA" KIT**

composed by:  
 1 milk pitcher Europa 0.75 L 1224011  
 1 milk pitcher Europa 0.50 L 1224010  
 1 cocoa duster 1094003  
 1 thermometer 1394554  
 1 tamper ø 58 mm 1385060  
 1 tamper holder 1385023  
 1 latte art pen 1394006

### **BARISTA KIT "ROMA"**

im Kit sind inbegriffen:  
 1 Milchkännchen Europa 0,75 L 1224011  
 1 Milchkännchen Europa 0,50 L 1224010  
 1 Kakaostreuer 1094003  
 1 Thermometer 1394554  
 1 Tamper ø 58 mm 1385060  
 1 Stütze für Tamper 1385023  
 1 Milchstift Art 1394006

### **BARISTA KIT "ROMA"**

se compone de:  
 1 lechera Europa 0,75 L 1224011  
 1 lechera Europa 0,50 L 1224010  
 1 espolvoreador de cacao 1094003  
 1 termometro 1394554  
 1 prensa café ø 58 mm 1385060  
 1 porta-prensa café 1385023  
 1 instrumento decoración para "latte art" 1394006

## 1950014

### **BARISTA KIT "MILANO"**

composto da:  
 1 lattiera Europa 0,50 L 1224010  
 1 lattiera Europa 0,35 L 1224015  
 1 spolveratore di cacao 1094003  
 1 termometro 1394554  
 1 pressino ø 58 mm 1385060  
 1 portapressino 1385023  
 1 penna latte art 1394006

### **BARISTA "MILANO" KIT**

composed by:  
 1 milk pitcher Europa 0.50 L 1224010  
 1 milk pitcher Europa 0.35 L 1224015  
 1 cocoa duster 1094003  
 1 thermometer 1394554  
 1 tamper ø 58 mm 1385060  
 1 tamper holder 1385023  
 1 latte art pen 1394006

### **BARISTA KIT "MILANO"**

im Kit sind inbegriffen:  
 1 Milchkännchen Europa 0,50 L 1224010  
 1 Milchkännchen Europa 0,35 L 1224015  
 1 Kakaostreuer 1094003  
 1 Thermometer 1394554  
 1 Tamper ø 58 mm 1385060  
 1 Stütze für Tamper 1385023  
 1 Milchstift Art 1394006





### **BARISTA KIT "MILANO"**

se compone de:  
 1 lechera Europa 0,50 L 1224010  
 1 lechera Europa 0,35 L 1224015  
 1 espolvoreador de cacao 1094003  
 1 termometro 1394554  
 1 prensa café ø 58 mm 1385060  
 1 porta-prensa café 1385023  
 1 instrumento decoración para "latte art" 1394006



LF Code	Milk jug (L)	Tamper
1950013	0.75 - 0.50	ø 58 mm
1950014	0.50 - 0.35	ø 58 mm



-  Lattiere
-  Milk pitchers
-  Milchgiesser
-  Lecheras



Metallurgica  
**MOTTA**



1224014



1224015



1224010



1224011



1224012



1224013

**Europa series**

LF Code	Capacity (L)
1224014	0.25
1224015	0.35
1224010	0.5
1224011	0.75
1224012	1
1224013	1.5

-  Lattiere
-  Milk pitchers
-  Milchgiesser
-  Lecheras



1



2



3



4



5

**Europa series**

Photo	LF Code	Capacity (L)
1	5057755	0.35
1	1224050	0.5
1	1224051	0.75
2	5057732	0.35
2	1224060	0.5
2	1224061	0.75
3	5079888	0.35
3	1224070	0.5
3	1224073	0.75
4	5079890	0.35
4	1224071	0.5
4	1224072	0.75
5	5068128	0.35
5	5066908	0.5
5	5066909	0.75



1224018



1224019



1224020

**Tulip series**

LF Code	Capacity (L)
1224018	0.50
1224019	0.50
1224020	0.50

-  Lattiere
-  Milk pitchers
-  Milchgiesser
-  Lecheras



1224021



1224022



1224023



1224024



1224025



1224026

### Aurora series

LF Code	Capacity (L)
1224021	0.25
1224022	0.35
1224023	0.5
1224024	0.75
1224025	1
1224026	1.5



 Personalizza gli articoli con il  
**Tuo Logo**

Quantità minime e costi di personalizzazione a richiesta

 Spezieller Aufdruck mit  
**Ihrem Logo**

Mindestbestimmungen und Kosten auf Anfrage

 Special customisation with  
**Your Logo**

Min. quantities and costs quoted on request

 Personalización de los artículos  
**Su Marca**

Cantidad mínima y costes de personalización a medida

-  Lattiere
-  Milk pitchers
-  Milchgiesser
-  Lecheras



1024001



1024002



1024003



1024004



1024005



1024006

**Pratika series**

LF Code	Capacity (L)
1024001	0.2
1024002	0.3
1024003	0.45
1024004	0.6
1024005	0.7
1024006	1.1



1024051



1024052

**Pratika series**

LF Code	Capacity (L)
1024051	0.6
1024052	0.7

-  Lattiere
-  Milk pitchers
-  Milchgiesser
-  Lecheras



1224030



1224031



1224032



**Évolution series**

LF Code	Capacity (L)
1224030	0.35
1224031	0.50
1224032	0.75



1224100



1224102



LF Code	Capacity (L)
1224100	0.35
1224102	0.60

-  Lattiere
-  Milk pitchers
-  Milchgiesser
-  Lecheras



1224911



1224912



1224913

LF Code	Capacity (L)
1224911	0.35
1224912	0.60
1224913	1.0



1224900



1224901



1224902



1224903



1224904

LF Code	Capacity (L)
1224900	0.10
1224901	0.35
1224902	0.60
1224903	1.0
1224904	1.5

-  Lattiere
-  Milk pitchers
-  Milchgiesser
-  Lecheras



1224016



1224017



LF Code	Dimensions (mm)	Mounting hole (mm)
1224016	175x162x127	155x140
1224017	175x162x127	---



1394553



1394554

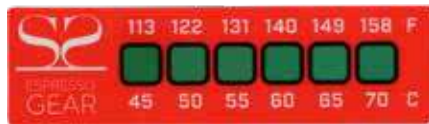

1394004

LF Code	Notes	Features
1394553	ANALOG THERMOMETER - TERMOMETRO	0+100°C - ø 25 mm
1394554	ANALOG THERMOMETER - TERMOMETRO	0+100°C - ø 45 mm
1394004	ADHESIVE THERMOMETER - TERMOMETRO ADESIVO	45+70°C

-  Libri
-  Books
-  Bücher
-  Libros



## 1000011

 **“LA FILIERA DEL CAFFÈ ESPRESSO” ITA-RUS**

VII° EDIZIONE - ITALIANO-RUSSO.  
Un libro dedicato alla filiera del caffè espresso composto da 4 capitoli:  
Verde: la pianta del caffè, i segreti della raccolta e della lavorazione dei frutti.  
Sacco: il lungo viaggio del caffè verde nei sacchi di juta, le caratteristiche dei chicchi e gli specialisti che le valutano.  
Tostato: il know-how della torrefazione e la metamorfosi del chicco di caffè.  
Espresso: la tecnologia italiana del caffè espresso e le regole d'oro per una tazza perfetta.

 **BOOK THE ESPRESSO COFFEE P. SYSTEM IT-RU**

VII° EDITION - ITALIAN-RUSSIAN LANGUAGES.  
Book dedicated to the espresso coffee prod. system composed by 4 chapters:  
Green: the coffee plant, the secrets of the harvesting and processing of fruits  
Sack: the long journey of the green coffee in burlap sacks, the beans characteristics and the specialists that check them.  
Roasted: the roasting know-how and the metamorphosis of the coffee bean.  
Espresso: Italian technology of the espresso coffee and the golden rules for a perfect coffee cup

 **BUCH ESPRESSO KAFFEE HERSTELLUNG ITA-RU**

VII° AUSGABE - ITALIENISCH-RUSSISCH.  
Ein Buch der Espresso Kaffee Herstellung gewidmet bestehend aus 4 Kapiteln:  
Grün: Die Kaffeepflanze, Geheimnisse der Ernte und Verarbeitung von Früchten.  
Sack: Die lange Reise des grünen Kaffee in Jutesäcke, die Eigenschaften der Bohnen und die Spezialisten, die sie bewerten.  
Geröstet: Das Know-how des Röstens und die Metamorphose der Kaffeebohne.  
Espresso: die ital. Kaffee Espresso Technologie u. die goldenen Regeln einer perfekten Kaffeetasse.

 **LIBRO LA LÍNEA DEL CAFÉ ESPRESSO ITA-RUS**

VII° EDICIÓN - ITALIANO - RUSO  
Un libro dedicado a la línea del café espresso compuesto de 4 capítulos:  
Verde: la planta del café, los secretos de la recolección de los frutos.  
Bolsa: el largo viaje del café verde en las bolsas de yute, las caracter. de los granos y de los especialistas que lo valoran.  
Tostado: el know-how de la torrefacción y la metamorfosis del grano de café.  
Espresso: la tecnología italiana del café espresso y la regla de oro p. una taza perfecta.



## 1000012

 **LIBRO “CAPPUCCINO LATTE ART” ITA/RUS**

IV° EDIZIONE - ITALIANO - RUSSO  
Il volume è composto da 7 capitoli:  
Cappuccino & Espresso  
Le 5 “L” del cappuccino  
La degustazione del cappuccino  
Mondo cappuccino  
I segreti della Latte Art  
New designs  
Cappuccino 3D

 **BOOK CAPPUCCINO LATTE ART IT-RU**

IV° EDITION - ITALIAN - RUSSIAN  
The volume is composed by 4 chapters:  
Cappuccino & Espresso  
The 5 “L” of the cappuccino  
The cappuccino taste  
The cappuccino world  
The milk Art secrets  
New designs  
Cappuccino 3D





 **BUCH CAPPUCCINO LATTE ART IT-RU**

IV° AUSGABE - ITALIENISCH - RUSSISCH  
Das Buch besteht aus 7 Kapiteln:  
Cappuccino & Espresso  
Die 5 “L” des Cappuccino  
Das Cappuccino Verkosten  
Das Cappuccino Welt  
Die Geheimnisse der Milch Art  
New designs  
Cappuccino 3D

 **LIBRO CAPUCHINO LATTE ART IT-RU**

IV° EDICIÓN - ITALIANO - RUSO  
El volumen está compuestos de 7 capítulos:  
Capuchino & Espresso  
Las 5 “L” del capuchino  
La degustación del capuchino  
Mundo capuchino  
Los secretos del Latte Art  
Nuevos diseños  
Capuchino 3D



-  Macine
-  Grinders
-  Mahlscheiben - Mahlwerke
-  Fresas

 **Macine Heavy duty - Long life**  
Durata maggiore del **+70%** rispetto ad una macina standard!

 **Heavy duty - Long life Grinding burrs**  
**+70%** longer life cycle compared to a standard grinding burr!

 **Mahlscheiben: Heavy duty - Long life**  
**+70%** längere Lebensdauer gegenüber normalen Mahlscheiben!

 **Molinos Heavy duty - Long life**  
Duración mayor del **+70%** respecto a una muela estándar



1251700



1251701



1251702



1251703



1251704



1251707



1251201



1251705



1251706





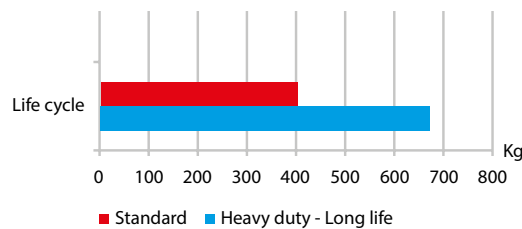

1251708



LF Code	Dimensions	LH/RH	Suitable for	Notes
1251703	ø 75x43.5x9 mm	DX-RH	CIMBALI	---
1251706	ø 68/49 mm - ø 40/11 mm H25 mm	DX-RH	CIMBALI	---
1251701	ø 63x38x9 mm	DX-RH	COMPAK	---
1251703	ø 75x43.5x9 mm	DX-RH	FAEMA	---
1251706	ø 68/49 mm - ø 40/11 mm H25 mm	DX-RH	FAEMA	---
1251705	ø 83/59 mm - ø 50/14 mm H25 mm	DX-RH	MAZZER	3-PHASE
1251704	ø 83x49x9.5 mm	DX-RH	MAZZER	1-PHASE
1251201	ø 71/49 mm - ø 41/14 mm H25 mm	DX-RH	MAZZER	1-PHASE
1251700	ø 64x38x8.5 mm	DX-RH	MAZZER	1-PHASE
1251708	ø 63/40 mm - ø 40/12 mm H23 mm	DX-RH	MAZZER	1-PHASE
1251702	ø 63.5x37,5x9 mm	SX-LH	OBEL	---
1251707	ø 63.5x38x9 mm	SX-LH	ROSSI	---
1251701	ø 63x38x9 mm	DX-RH	WEGA	---



-  Manopole portafiltro
-  Handles for filterholder-portafilter
-  Griffe für Siebträger
-  Mandos portafiltro



1



2



3

Photo	LF Code	Connection	Suitable for
1	1241505	M10	ALL BRANDS - TUTTE LE MARCHE
1	1241504	M12	ALL BRANDS - TUTTE LE MARCHE
2	1241269	M10	ALL BRANDS - TUTTE LE MARCHE
2	1241169	M12	ALL BRANDS - TUTTE LE MARCHE
3	1241502	M10	ALL BRANDS - TUTTE LE MARCHE
3	1241501	M12	ALL BRANDS - TUTTE LE MARCHE



1



2

Photo	LF Code	Connection	Suitable for
1	5051751	M10	ALL BRANDS - TUTTE LE MARCHE
1	5051102	M12	ALL BRANDS - TUTTE LE MARCHE
2	5054506	M10	ALL BRANDS - TUTTE LE MARCHE
2	5054505	M12	ALL BRANDS - TUTTE LE MARCHE



1







2







3

Photo	LF Code	Connection	Suitable for
1	1141006	M10	ALL BRANDS - TUTTE LE MARCHE
1	1141007	M12	ALL BRANDS - TUTTE LE MARCHE
2	1141004	M10	ALL BRANDS - TUTTE LE MARCHE
2	1141003	M12	ALL BRANDS - TUTTE LE MARCHE
3	5083515	M10	ALL BRANDS - TUTTE LE MARCHE
3	5055983	M12	ALL BRANDS - TUTTE LE MARCHE

-  Portafiltri macchine caffè
-  Filter holders for coffee machines
-  Siebträger für Kaffeemaschinen
-  Porta-filtros para máquinas de café







LF Code	Suitable for	Wings	Adapter filter for pods	Notes
1165034	ASTORIA/CMA	6.0 mm	No	---
1165117	ASTORIA/CMA	6.5 mm	No	Plus 4 you
1165181	BEZZERA	5.8 mm	Yes	---
1165216	BFC	6.2 mm	No	---
1165189	BIANCHI	6.4 mm	Yes	---
1165035	BRASILIA	5.5 mm	Yes	---
1165183	BRUGNETTI	7.2 mm	Yes	---
1165038	CARIMALI	6.0 mm	No	---
1165183	CASADIO	7.2 mm	Yes	---
1165182	CIMBALI	5.5 mm	Yes	---
1165039	CONTI	8.0 mm	No	---
1165119	DALLA CORTE	9.0 mm	No	---
1165183	ECM	7.2 mm	Yes	---
1165193	ECM MANUFACTURE	6.4 mm	Yes	---
1165189	ELEKTRA	6.4 mm	Yes	---
1165192	EXPOBAR	6.2 mm	Yes	---
1165183	FAEMA	7.2 mm	Yes	---
1165189	FIAMMA RST	6.4 mm	Yes	---
1165195	FIORENZATO CS	6.4 mm	Yes	---
1165184	FUTURMAT	7.2 mm	No	---
1165185	GAGGIA	6.6 mm	Yes	---
1165184	GAGGIA SPAGNA	7.2 mm	No	---
1165194	GRIMAC	7.0 mm	Yes	---
1165191	GRUPPO IZZO	7.0 mm	Yes	---
1165189	ISOMAC	6.4 mm	Yes	---
1165184	ITALCREM	7.2 mm	No	---
1165195	MAGISTER	6.4 mm	Yes	---
1165184	MAIRALI	7.2 mm	No	---
1165186	MARZOCCO	6.6 mm	Yes	---
5038578	MARZOCCO	6.0 mm	Yes	Original - no filter
1165189	MCE	6.4 mm	Yes	---
1165118	NUOVA SIMONELLI	7.0 mm	No	Slanted body / Corpo inclinato
1165189	ORCHESTRALE	6.4 mm	Yes	---
5030988	PAVONI	5.6 mm	Yes	---
1165187	PROMAC	6.2 mm	Yes	---
1165189	QUICK MILL	6.4 mm	Yes	---
1165187	RANCILIO	6.2 mm	Yes	---
1165216	ROYAL	6.2 mm	No	---
1165185	SAECO	6.6 mm	No	---
1165191	SAN MARCO	7.0 mm	Yes	---
1165193	SANREMO	6.4 mm	Yes	---
1165189	SCALA	6.4 mm	Yes	---
5050620	SPAZIALE	6.0 mm	Yes	---
1165329	SYNESSO	5.9 mm	No	---
1165188	VIBIEMME	6.2 mm	Yes	---
1165118	VICTORIA ARDUINO	7.0 mm	No	Slanted body / Corpo inclinato
1165184	VISACREM	7.2 mm	No	---
1165189	WEGA	6.4 mm	Yes	---
1165117	WEGA	6.5 mm	No	Concept

-  Portafiltri macchine caffè
-  Filter holders for coffee machines
-  Siebträger für Kaffeemaschinen
-  Porta-filtros para máquinas de café



LF Code	Suitable for	Wings	Adapter filter for pods	Notes
1165219	ASTORIA	6.0 mm	Yes	---
1165219	BEZZERA	6.0 mm	Yes	---
5086956	BFC	6.2 mm	Yes	---
1165222	BIANCHI	6.4 mm	Yes	---
5085669	BRASILIA	7.2 mm	Yes	---
5085669	BRUGNETTI	7.2 mm	Yes	---
5085669	CASADIO	7.2 mm	Yes	---
1165220	CIMBALI	5.5 mm	Yes	---
5085669	ECM	7.2 mm	Yes	---
5086956	ECM MANUFACTURE	6.2 mm	Yes	---
1165222	ELEKTRA	6.4 mm	Yes	---
5086956	EXPOBAR	6.2 mm	Yes	---
5085669	FAEMA	7.2 mm	Yes	---
1165222	FIAMMA RST	6.4 mm	Yes	---
1165222	FIORENZATO CS	6.4 mm	Yes	---
5085669	FUTURMAT	7.2 mm	Yes	---
1165221	GAGGIA	6.6 mm	Yes	---
5085669	GAGGIA SPAGNA	7.2 mm	Yes	---
5085669	GRIMAC	7.2 mm	Yes	---
1165223	GRUPPO IZZO	7.0 mm	Yes	---
1165222	ISOMAC	6.4 mm	Yes	---
5085669	ITALCREM	7.2 mm	Yes	---
1165222	MAGISTER	6.4 mm	Yes	---
5085669	MAIRALI	7.2 mm	Yes	---
5086954	MARZOCCO	6.6 mm	Yes	---
1165222	MCE	6.4 mm	Yes	---
1165218	NUOVA SIMONELLI	7.0 mm	NO	Slanted body / Corpo inclinato
1165222	ORCHESTRALE	6.4 mm	Yes	---
5086956	PROMAC	6.2 mm	Yes	---
1165222	QUICK MILL	6.4 mm	Yes	---
5086956	RANCILIO	6.2 mm	Yes	---
5086956	ROYAL	6.2 mm	Yes	---
1165221	SAECO	6.6 mm	Yes	---
1165223	SAN MARCO	7.0 mm	Yes	---
5086956	SANREMO	6.2 mm	Yes	---
1165222	SCALA	6.4 mm	Yes	---
1165224	SPAZIALE	6.0 mm	Yes	---
5086956	VIBIEMME	6.2 mm	Yes	---
1165218	VICTORIA ARDUINO	7.0 mm	NO	Slanted body / Corpo inclinato
5085669	VISACREM	7.2 mm	Yes	---
1165222	WEGA	6.4 mm	Yes	---

-  Portafiltri macchine caffè
-  Filter holders for coffee machines
-  Siebträger für Kaffeemaschinen
-  Porta-filtros para máquinas de café



**Cialde caffè/orzo**  
Barley/Coffee Pods  
Kaffee/Gerstenkaffee Pads  
Dosis de café/cebada

LF Code	Suitable for	Wings
1165162	BEZZERA - BFC - BRASILIA - BRUGNETTI AURORA - CONTI	6.5 mm
1165162	EXPOBAR - FIORENZATO CS - GRIMAC - RANCILIO - ROYAL	6.5 mm
1165162	SANREMO - SCALA - VIBIEMME - WEGA	6.5 mm
1165163	CIMBALI	5.5 mm
1165032	FAEMA	6.3 mm
1165165	GRUPPO IZZO - MY WAY - SAN MARCO	7.4 mm
1165164	SPAZIALE	6.0 mm



**La regolazione del flusso avviene tramite la rotazione della manopola**

Flow regulation by handle rotation





Durchflussregulierung durch Drehung des Griffs

La regulación del flujo se realiza a través de la rotación del mando



**Cialde orzo**  
Barley Pods  
Gerstenkaffee Pads  
Dosis de cebada

LF Code	Suitable for	Wings
1165085	ASTORIA/CMA	5.4 mm
1165166	ASTORIA/CMA Plus4you	5.0 mm
1165202	BEZZERA	5.5 mm
1165151	CIMBALI	8.0 mm
1165167	DALLA CORTE	8.0 mm
1165152	FAEMA	6.4 mm
1165153	FUTURMAT	6.8 mm
1165158	GAGGIA	6.5 mm
1165159	GRUPPO IZZO / MY WAY	8.0 mm
1165154	NUOVA SIMONELLI	7.0 mm
1165155	RANCILIO	6.0 mm
1165159	SAN MARCO	8.0 mm
1165160	SPAZIALE	8.4 mm
1165156	VIBIEMME	6.0 mm
1165157	WEGA	6.5 mm
1165166	WEGA CONCEPT	5.0 mm

-  Portafiltri macchine caffè
-  Filter holders for coffee machines
-  Siebträger für Kaffeemaschinen
-  Porta-filtros para máquinas de café



LF Code	Suitable for	Wings	Notes
5073894	ASTORIA/CMA PLUS4YOU	7.0 mm	0-120°C / 0-240°F - 0-16 bar / 0-200 psi
5073895	BEZZERA	5.5 mm	0-120°C / 0-240°F - 0-16 bar / 0-200 psi
1165500	BFC	7.2 mm	0-120°C / 0-240°F - 0-16 bar / 0-200 psi
1165500	BRASILIA	7.2 mm	0-120°C / 0-240°F - 0-16 bar / 0-200 psi
5073893	CIMBALI	6.2 mm	0-120°C / 0-240°F - 0-16 bar / 0-200 psi
1165500	CONTI	7.2 mm	0-120°C / 0-240°F - 0-16 bar / 0-200 psi
1165500	ELEKTRA	7.2 mm	0-120°C / 0-240°F - 0-16 bar / 0-200 psi
1165500	EXPOBAR	7.2 mm	0-120°C / 0-240°F - 0-16 bar / 0-200 psi
1165500	FAEMA	7.2 mm	0-120°C / 0-240°F - 0-16 bar / 0-200 psi
1165500	FUTURMAT/ARIETE	7.2 mm	0-120°C / 0-240°F - 0-16 bar / 0-200 psi
5073891	GRUPPO IZZO / MY WAY	7.4 mm	0-120°C / 0-240°F - 0-16 bar / 0-200 psi
5073892	MARZOCCO	6.6 mm	0-120°C / 0-240°F - 0-16 bar / 0-200 psi
5070800	NUOVA SIMONELLI	7.0 mm	0-120°C / 0-240°F - 0-16 bar / 0-200 psi
1165500	RANCILIO	7.2 mm	0-120°C / 0-240°F - 0-16 bar / 0-200 psi
5073891	SAN MARCO	7.4 mm	0-120°C / 0-240°F - 0-16 bar / 0-200 psi
1165500	SANREMO	7.2 mm	0-120°C / 0-240°F - 0-16 bar / 0-200 psi
5067922	SPAZIALE	6.0 mm	0-120°C / 0-240°F - 0-16 bar / 0-200 psi
1165500	VIBIEMME	7.2 mm	0-120°C / 0-240°F - 0-16 bar / 0-200 psi
1165500	WEGA	7.2 mm	0-120°C / 0-240°F - 0-16 bar / 0-200 psi
5073894	WEGA CONCEPT	7.0 mm	0-120°C / 0-240°F - 0-16 bar / 0-200 psi
5072000	---	---	0-120°C / 0-240°F - 0-16 bar / 0-200 psi



1



2







3



Photo	LF Code	Wings	Knob	Spouts	Filter	Spring	Suitable for	Notes
1	1165252	6.6 mm	M12	3/8	NO	NO	MARZOCCO	NON-STICK COATING MADE OF NANOQUARTZ
1	1165255	6.6 mm	M12	3/8	NO	NO	MARZOCCO	NON-STICK COATING MADE OF NANOQUARTZ
1	1165253	5.9 mm	M10	3/8	NO	NO	MARZOCCO	NON-STICK COATING MADE OF NANOQUARTZ
1	1165254	7.0 mm	M10	3/8	NO	NO	NUOVA SIMONELLI - VICTORIA ARDUINO	NON-STICK COATING MADE OF NANOQUARTZ

Photo	LF Code	Connection (ø)	Notes
2	1165257	3/8	COATED WITH NANOQUARTZ - RIVESTITI IN NANOQUARZO
3	1165256	3/8	COATED WITH NANOQUARTZ - RIVESTITI IN NANOQUARZO





-  Portafiltri macchine caffè
-  Filter holders for coffee machines
-  Siebträger für Kaffeemaschinen
-  Porta-filtros para máquinas de café



Compatibile con Lavazza Blue®  
 Compatible with Lavazza Blue®  
 Passend für Lavazza Blue®  
 Compatible con Lavazza Blue®

LF Code	Suitable for	Wings
1165245	ASTORIA CMA	6.0 mm
1165249	ASTORIA/CMA Plus4you	6.5 mm
1165245	BEZZERA	6.0 mm
1165251	BFC	6.2 mm
1165241	BIANCHI	6.4 mm
1165244	BRASILIA	5.5 mm
5083605	BRUGNETTI AURORA	7.2 mm
5085454	CARIMALI	6.0 mm
5083605	CASADIO	7.2 mm
5083604	CIMBALI	6.5 mm
1165247	DALLA CORTE	9.0 mm
5083605	ECM	7.2 mm
1165241	ELEKTRA	6.4 mm
1165251	EXPOBAR	6.2 mm
5083605	FAEMA	7.2 mm
1165241	FIAMMA RST	6.4 mm
1165241	FIORENZATO C.S.	6.4 mm
5083605	FUTURMAT	7.2 mm
1165248	GAGGIA	6.6 mm
5083605	GRIMAC	7.2 mm
5088433	GRUPPO IZZO / MY WAY	6.5 mm
1165241	ISOMAC	6.4 mm
1165243	MARZOCCO	6.6 mm
1165241	MCE	6.4 mm
1165250	NUOVA SIMONELLI	6.5 mm
1165241	ORCHESTRALE	6.4 mm
1165242	PAVONI	5.6 mm
1165251	PROMAC	6.2 mm
1165241	QUICK MILL	6.4 mm
1165251	RANCILIO	6.2 mm
1165251	ROYAL	6.2 mm
1165248	SAECO	6.6 mm
5088433	SAN MARCO	6.5 mm
1165251	SANREMO	6.2 mm
1165241	SCALA	6.4 mm
1165246	SPAZIALE	6.0 mm
1165251	VIBIEMME	6.2 mm
1165250	VICTORIA ARDUINO	6.5 mm
1165241	WEGA	6.4 mm
1165249	WEGA Concept	6.5 mm



-  Portafiltri macchine caffè
-  Filter holders for coffee machines
-  Siebträger für Kaffeemaschinen
-  Porta-filtros para máquinas de café

## 5083606

### **PRESSINO PERFORATORE CAPSULE LAVAZZA**

pressino con perforatore adatto a perforare capsule compatibili Lavazza  
 ø pressino 53 mm  
 ø perforatore 27 mm

### **CAPSULES PERFORATOR TAMPER LAVAZZA**

tamper with perforator specific to perforate capsules suitable for Lavazza  
 tamper ø 53 mm  
 perforator ø 27 mm

### **KAPSELBOHRER TAMPER LAVAZZA**

Tamper mit Bohrer spezifisch um Lavazza passende Kapseln zu perforieren  
 Tamper-ø 53 mm  
 Perforierer-ø 27 mm

### **PRENSA PERFORADOR CÁPSULAS LAVAZZA**

prensa con perforador para perforar cápsulas compatibles Lavazza  
 ø prensa 53 mm  
 ø perforador 27 mm



## 1385081



### **STAZIONE DI PERFORATURA CAPSULE ø 58 mm**

pressino con perforatore adatto a perforare capsule compatibili Lavazza  
 ø pressino 58 mm  
 ø perforatore 27 mm - 13 denti  
 altezza totale 280 mm  
 larghezza 140 mm  
 profondità 160 mm

### **CAPSULES PERFORATOR STATION ø 58 mm**

tamper with perforator suitable for drilling Lavazza compatible capsules  
 tamper ø 58 mm  
 perforator ø 27 mm - 13 teeth  
 overall height 280 mm  
 width 140 mm  
 depth 160 mm

### **KAPSELBOHRERSTATION ø 58 mm**

Tamper mit Bohrer geeignet für Lavazza kompatible Kapseln  
 Tamper ø 58 mm  
 Bohrer ø 27 mm - 13 Zähne  
 Gesamthöhe 280 mm  
 Breite 140 mm  
 Tiefe 160 mm

### **ESTACIÓN DE PERFORACIÓN CÁPSULAS ø 58 mm**

prensa con perforador apta para perforar cápsulas compatibles con Lavazza  
 ø prensa 58 mm  
 ø perforador 27 mm - 13 dientes  
 altura total 280 mm  
 anchura 140 mm  
 profundidad 160 mm



Compatible con Lavazza Blue®  
 Compatible with Lavazza Blue®  
 Passend für Lavazza Blue®  
 Compatible con Lavazza Blue®

LF Code	ø	Material	Pressing zone
5083606	53 mm	ALUMINIUM - ALLUMINIO	FLAT - PIATTA
1385081	58 mm	STAINLESS STEEL - ACCIAIO INOX	FLAT - PIATTA



1



Photo	LF Code	∅	Material	Pressing zone
1	1385066	58 mm	WOOD & STAINLESS S. - LEGNO E INOX	FLAT - PIATTA
1	1385067	57 mm	WOOD & STAINLESS S. - LEGNO E INOX	FLAT - PIATTA
1	1385068	53 mm	WOOD & STAINLESS S. - LEGNO E INOX	FLAT - PIATTA
1	1385069	48 mm	WOOD & STAINLESS S. - LEGNO E INOX	FLAT - PIATTA



1



2



3



4

Photo	LF Code	∅	Material	Pressing zone
1	1385150	58 mm	ALUMINIUM STAINLESS S. - ALLUMINIO E INOX	FLAT - PIATTA
1	1385154	57 mm	ALUMINIUM STAINLESS S. - ALLUMINIO E INOX	FLAT - PIATTA
2	1385151	58 mm	ALUMINIUM STAINLESS S. - ALLUMINIO E INOX	FLAT - PIATTA
2	1385155	57 mm	ALUMINIUM STAINLESS S. - ALLUMINIO E INOX	FLAT - PIATTA
3	1385152	58 mm	ALUMINIUM STAINLESS S. - ALLUMINIO E INOX	FLAT - PIATTA
3	1385156	57 mm	ALUMINIUM STAINLESS S. - ALLUMINIO E INOX	FLAT - PIATTA
4	1385153	58 mm	ALUMINIUM STAINLESS S. - ALLUMINIO E INOX	FLAT - PIATTA
4	1385157	57 mm	ALUMINIUM STAINLESS S. - ALLUMINIO E INOX	FLAT - PIATTA



1



2



3

Photo	LF Code	ø	Material	Pressing zone
1	1385158	58 mm	ALUMINIUM STAINLESS S. - ALLUMINIO E INOX	FLAT - PIATTA
1	1385160	57 mm	ALUMINIUM STAINLESS S. - ALLUMINIO E INOX	FLAT - PIATTA
2	1385159	58 mm	ALUMINIUM STAINLESS S. - ALLUMINIO E INOX	FLAT - PIATTA
2	1385161	57 mm	ALUMINIUM STAINLESS S. - ALLUMINIO E INOX	FLAT - PIATTA
3	1385162	58 mm	ALUMINIUM STAINLESS S. - ALLUMINIO E INOX	FLAT - PIATTA
3	1385163	57 mm	ALUMINIUM STAINLESS S. - ALLUMINIO E INOX	FLAT - PIATTA



1



2



3

Photo	LF Code	ø	Material	Pressing zone
1	1385190	58 mm	ALUMINIUM STAINLESS S. - ALLUMINIO E INOX	FLAT - PIATTA
1	1385191	57 mm	ALUMINIUM STAINLESS S. - ALLUMINIO E INOX	FLAT - PIATTA
2	1385192	58 mm	ALUMINIUM STAINLESS S. - ALLUMINIO E INOX	FLAT - PIATTA
2	1385193	57 mm	ALUMINIUM STAINLESS S. - ALLUMINIO E INOX	FLAT - PIATTA
3	1385194	58 mm	ALUMINIUM STAINLESS S. - ALLUMINIO E INOX	FLAT - PIATTA
3	1385195	57 mm	ALUMINIUM STAINLESS S. - ALLUMINIO E INOX	FLAT - PIATTA



1





2



3

Photo	LF Code	ø	Material	Pressing zone
1	1385180	58 mm	WOOD STAINLESS S. - LEGNO E INOX	FLAT - PIATTA
1	1385182	57 mm	WOOD STAINLESS S. - LEGNO E INOX	FLAT - PIATTA
2	1385181	58 mm	WOOD STAINLESS S. - LEGNO E INOX	FLAT - PIATTA
2	1385183	57 mm	WOOD STAINLESS S. - LEGNO E INOX	FLAT - PIATTA
3	1385184	58 mm	WOOD STAINLESS S. - LEGNO E INOX	FLAT - PIATTA
3	1385185	57 mm	WOOD STAINLESS S. - LEGNO E INOX	FLAT - PIATTA

-  Pressini
-  Tamper for coffee
-  Tamper - Kaffeepresser
-  Prensas café



## The King



1385071



1385073



1385074



1385072



LF Code	ø	Material	Pressing zone
1385071	58.5 mm	ALLUMINIO - ALUMINUM	FLAT - PIATTA
1385073	58.5 mm	ALLUMINIO - ALUMINUM	FLAT - PIATTA
1385074	58.5 mm	ALLUMINIO - ALUMINUM	FLAT - PIATTA
1385072	58.5 mm	ALLUMINIO - ALUMINUM	FLAT - PIATTA

### **PRESSINO THE KING** ø 58,5 mm

Dotato di regolazione di profondità, per garantire una pressatura livellata e uniforme.  
Riduce al minimo le possibilità di errore e le variazioni di pressatura tra baristi diversi.  
Forma ergonomica per ridurre tensione e rischio di lesione da sovrautilizzo.

### **TAMPER THE KING** ø 58.5 mm

Equipped with depth adjustment, to ensure a smooth and uniform pressing.  
Minimises the possibility of error occurring and variations in pressure for different baristas.  
Ergonomic shape which reduces tension and risk of overuse

### **TAMPER THE KING** ø 58,5 mm

Ausgerüstet m/Tiefeneinstellung, um einen gleichm. und nivellierten Druck zu gewährleisten.  
Minimiert Fehlermöglichkeit u/Drückvariation zwischen verschiedener Baristas.  
Ergonom. Form, um die Spannung u/Verletzungsgefahr durch Überbenutzung zu reduzieren.

### **PRENSA CAFÈ THE KING** ø 58,5 mm

Dotado de regulación de profundidad, p. garantizar un prensado nivelado y uniforme.  
Reduce al mínimo la posibilidad de error y la variación de prensado entre diferentes baristas.  
Forma ergonómica p. reducir la tensión y el riesgo de lesión por sobreutilización.

## The Jack



1385077



1385078



1385079



1385080



5097416



LF Code	ø	Material	Pressing zone	Notes
1385077	58.5 mm	S/STEEL - INOX	4 FLAT BLADES - 4 LAME PIATTE	ADJUSTABLE - REGOLABILE
1385078	58.5 mm	S/STEEL - INOX	4 FLAT BLADES - 4 LAME PIATTE	ADJUSTABLE - REGOLABILE
1385079	58.5 mm	S/STEEL - INOX	4 FLAT BLADES - 4 LAME PIATTE	ADJUSTABLE - REGOLABILE
1385080	58.5 mm	S/STEEL - INOX	4 FLAT BLADES - 4 LAME PIATTE	ADJUSTABLE - REGOLABILE
5097416	58.5 mm	S/STEEL - INOX	4 FLAT BLADES - 4 LAME PIATTE	ADJUSTABLE - REGOLABILE

  
**DISTRIBUTORE CAFFÈ**  
**THE JACK ø 58,5 mm**

Dotato di 4 lame piatte in grado di distribuire efficacemente e uniformemente il caffè nel filtro, creando una cialda di spessore uguale.  
 Elimina le problematiche legate alla distribuzione diseguale del caffè.  
 Crea una superficie perfettamente piana per una pressatura corretta su cialda di uguale spessore.  
 Riduce il rischio di channelling/micro-channelling.  
 Corpo ø 72 mm.  
 Regolabile in altezza.

  
**COFFEE LEVELLER**  
**THE JACK ø 58.5 mm**

equipped with 4 flat blades that distribute effectively and uniformly coffee in the filter, providing a pod of equal thickness.  
 Eliminates issues relating to the unequal distribution of coffee.  
 Creates a perfectly flat surface for uniform pressing and provides a pod of equal thickness.  
 Reduces the risk of channelling/micro-channelling.  
 Body ø 72 mm  
 Adjustable height

  
**LEVELLER TAMPER**  
**THE JACK ø 58,5 mm**

Mit 4 flachen Klingen, die den Kaffee effektiv und gleichmäßig im Filter verteilen, erzeugt ein Kaffeepad mit gleicher Dicke.  
 Beseitigt Verteilungsprobleme ungleicher Kaffee.  
 Erzeugt eine perfekt ebene Oberfläche für gleichm. Pressen und ein Kaffeepad m/gleich. Dicke.  
 Reduziert Channelling/Mikro-channelling Risiko.  
 Körper ø 72 mm.  
 Einstellbare Höhe.

  
**NIVELADOR CAFÉ**  
**THE JACK ø 58,5 mm**

Equipado con 4 cuchillas planas para distribuir de manera efectiva y uniforme el café en el filtro, creando pastilla de igual espesor.  
 Elimina problemas de distribución desigual del café.  
 Crea una superficie perfectamente plana para un prensado uniforme y una pastilla de igual espesor.  
 Reduce el riesgo de channelling/micro-channelling.  
 Cuerpo ø 72 mm.  
 Altura regulable.



1385716



1385715



1385717



1385718



1385064

LF Code	Description
1385716	M8 ALUMINIUM - M8 ALLUMINIO
1385715	M8 ALUMINIUM - M8 ALLUMINIO
1385717	M8 ALUMINIUM - M8 ALLUMINIO
1385718	M8 ALUMINIUM - M8 ALLUMINIO
1385064	M8 MARBLE - M8 MARMO



1



2

Photo	LF Code	ø	Material	Pressing zone
1	1385733	58 mm	STAINLESS STEEL - INOX	CONVEX - CONVESSA
1	1385732	57 mm	STAINLESS STEEL - INOX	CONVEX - CONVESSA
1	1385731	53 mm	STAINLESS STEEL - INOX	CONVEX - CONVESSA
1	1385730	58 mm	STAINLESS STEEL - INOX	FLAT - PIATTA
1	1385729	57 mm	STAINLESS STEEL - INOX	FLAT - PIATTA
1	1385726	54 mm	STAINLESS STEEL - INOX	FLAT - PIATTA
1	1385725	53 mm	STAINLESS STEEL - INOX	FLAT - PIATTA
1	1385724	52 mm	STAINLESS STEEL - INOX	FLAT - PIATTA
1	1385723	51 mm	STAINLESS STEEL - INOX	FLAT - PIATTA
1	1385722	50 mm	STAINLESS STEEL - INOX	FLAT - PIATTA
1	1385721	49 mm	STAINLESS STEEL - INOX	FLAT - PIATTA
1	1385720	48 mm	STAINLESS STEEL - INOX	FLAT - PIATTA
1	1385719	41 mm	STAINLESS STEEL - INOX	FLAT - PIATTA
2	1385745	58 mm	STAINLESS STEEL - INOX	CONVEX - CONVESSA
2	1385744	57 mm	STAINLESS STEEL - INOX	CONVEX - CONVESSA
2	1385740	58 mm	STAINLESS STEEL - INOX	FLAT - PIATTA
2	1385739	57 mm	STAINLESS STEEL - INOX	FLAT - PIATTA



1385761



1385756



1385754

LF Code	ø	Material	Pressing zone
1385761	58 mm	STAINLESS STEEL - INOX	FLAT - PIATTA
1385756	53 mm	STAINLESS STEEL - INOX	FLAT - PIATTA
1385754	58 mm	ALUMINIUM - ALLUMINIO	FLAT - PIATTA



1385701



1385702



1385703



1385704

LF Code	Description	Pressure (Kg)
1385701	M8 ALUMINIUM - M8 ALLUMINIO	8÷21
1385702	M8 ALUMINIUM - M8 ALLUMINIO	8÷21
1385703	M8 ALUMINIUM - M8 ALLUMINIO	8÷21
1385704	M8 ALUMINIUM - M8 ALLUMINIO	8÷21



1385766



1385765



1385764

LF Code	ø	Material	Pressing zone
1385766	58 mm	ALUMINIUM - ALLUMINIO	FLAT - PIATTA
1385765	57 mm	ALUMINIUM - ALLUMINIO	FLAT - PIATTA
1385764	53 mm	ALUMINIUM - ALLUMINIO	FLAT - PIATTA





1385774



1385772



1385770



1385771

LF Code	Description
1385774	FILTER HOLDER - SUPPORTO PORTAFILTRO
1385772	FILTER HOLDER - SUPPORTO PORTAFILTRO
1385770	FILTER HOLDER - SUPPORTO PORTAFILTRO
1385771	FILTER HOLDER - SUPPORTO PORTAFILTRO



1385776



1385778

LF Code	Description
1385776	WOODER TAMPER HOLDER - PORTAPRESSINO LEGNO
1385778	BLACK MAT - TAPPETINO APPOGGIO NERO



1



2



3



4

Photo	LF Code	ø	Material	Pressing zone
1	1385042	58 mm	ALUMINIUM - ALLUMINIO	FLAT - PIATTA
1	1385041	57 mm	ALUMINIUM - ALLUMINIO	FLAT - PIATTA
1	1385040	53 mm	ALUMINIUM - ALLUMINIO	FLAT - PIATTA
2	1385053	58 mm	ALUMINIUM - ALLUMINIO	FLAT - PIATTA
2	1385054	53 mm	ALUMINIUM - ALLUMINIO	FLAT - PIATTA
3	1385056	58 mm	ALUMINIUM - ALLUMINIO	FLAT - PIATTA
3	1385057	57 mm	ALUMINIUM - ALLUMINIO	FLAT - PIATTA
4	1385075	58 mm	ALUMINIUM - ALLUMINIO	FLAT - PIATTA
4	1385005	57 mm	ALUMINIUM - ALLUMINIO	FLAT - PIATTA
4	1385004	53 mm	ALUMINIUM - ALLUMINIO	FLAT - PIATTA



1



2



3





4



5

Photo	LF Code	ø	Material	Pressing zone
1	1385026	58 mm	WOOD AND S/STEEL - LEGNO E INOX	CONVEX - CONVESSA
1	1385060	58 mm	WOOD AND S/STEEL - LEGNO E INOX	FLAT - PIATTA
1	1385031	57 mm	WOOD AND S/STEEL - LEGNO E INOX	FLAT - PIATTA
1	1385061	53 mm	WOOD AND S/STEEL - LEGNO E INOX	FLAT - PIATTA
1	1385062	48 mm	WOOD AND S/STEEL - LEGNO E INOX	FLAT - PIATTA
2	1385029	58 mm	WOOD AND S/STEEL - LEGNO E INOX	CONVEX - CONVESSA
2	1385027	58 mm	WOOD AND S/STEEL - LEGNO E INOX	FLAT - PIATTA
2	1385033	57 mm	WOOD AND S/STEEL - LEGNO E INOX	FLAT - PIATTA
2	1385035	53 mm	WOOD AND S/STEEL - LEGNO E INOX	FLAT - PIATTA
3	1385028	58 mm	WOOD AND S/STEEL - LEGNO E INOX	CONVEX - CONVESSA
3	1385043	58 mm	WOOD AND S/STEEL - LEGNO E INOX	FLAT - PIATTA
3	1385032	57 mm	WOOD AND S/STEEL - LEGNO E INOX	FLAT - PIATTA
3	1385034	53 mm	WOOD AND S/STEEL - LEGNO E INOX	FLAT - PIATTA
4	1385036	58 mm	WOOD AND S/STEEL - LEGNO E INOX	CONVEX - CONVESSA
4	1385037	58 mm	WOOD AND S/STEEL - LEGNO E INOX	FLAT - PIATTA
4	1385038	57 mm	WOOD AND S/STEEL - LEGNO E INOX	FLAT - PIATTA
4	1385039	53 mm	WOOD AND S/STEEL - LEGNO E INOX	FLAT - PIATTA
5	1385076	58 mm	WOOD AND S/STEEL - LEGNO E INOX	FLAT - PIATTA

-  Pressini
-  Tamper for coffee
-  Tamper - Kaffeepresser
-  Prensas café



1385047



1385023



1385024



1385025

LF Code	Description
1385047	WOODER TAMPER HOLDER - PORTAPRESSINO LEGNO
1385023	S/STEEL TAMPER HOLDER - PORTAPRESSINO INOX
1385024	FILTER OLDER - SUPPORTO PORTAFILTRO
1385025	FILTER OLDER - SUPPORTO PORTAFILTRO

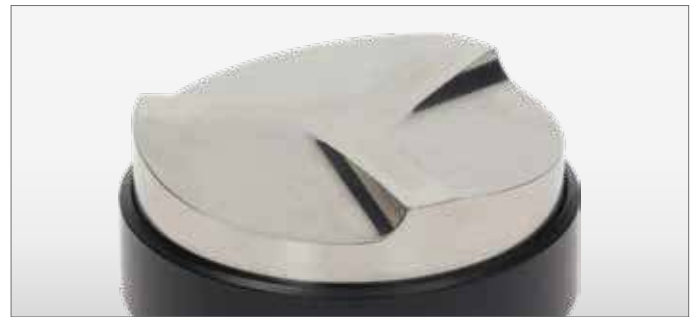

## 1385070

 **PIANACAFFÈ**

Dotato di tre lame piatte in grado di distribuire efficacemente e uniformemente il caffè nel filtro, creando una cialda di spessore uguale. Elimina le problematiche legate alla distribuzione diseguale del caffè. Crea una superficie perfettamente piana per una pressatura corretta su cialda di uguale spessore. Riduce il rischio di channelling/micro-channelling.

 **COFFEE LEVELER**

With 3 flat blades which distributes coffee into the filter in an effect. and uniform way. Therefore it creates a pod of equal thickness. Eliminating issues related to uneven coffee distribution. Creates a perfectly flat surface for a correct pressure on pods of equal thickness. Reduces the risk of channelling and micro-channelling.





 **HOCHPRÄZISIONS-LEVELLER TAMPER**

Es verfügt über drei flache Messer, die den Kaffee im Filter effizient und gleichmäßig verteilen, um einen ebenmäßigen Pad zu erzeugen. Es beseitigt so das Problem der ungleichen Verteilung des Kaffees. Die Oberfläche ist perfekt eben um den richtigen Druck auf Pads mit gleicher Dicke auszuüben. Reduziert Channelling u/Micro-Channelling Risiko.

 **NIVELADOR CAFÉ**

Dotado de 3 laminas planas que permiten distribuir eficaz y uniformemente el café en el filtro, creando una cápsula con el mismo espesor. Elimina todo tipo de problemas relacionados con la distribución desigual del café. Crea una superficie perfecta para un prensado correcto creando una cápsula de igual espesor. Reduce riesgo de channelling y micro-channelling.

LF Code	ø	Material	Pressing zone
1385070	58 mm	S/STEEL - INOX	3 FLAT BLADES - 3 LAME PIATTE
1385086	57 mm	S/STEEL - INOX	3 FLAT BLADES - 3 LAME PIATTE
1385087	53 mm	S/STEEL - INOX	3 FLAT BLADES - 3 LAME PIATTE

-  Pressini
-  Tamper for coffee
-  Tamper - Kaffeepresser
-  Prensas café



1



2

**IMS**  
COMPETITION SERIES



Photo	LF Code	ø	Material	Pressing zone
1	1385810	53 mm	S/STEEL	FLAT - PIATTA
1	1385811	54,4 mm	S/STEEL	FLAT - PIATTA
1	1385812	57,4 mm	S/STEEL	FLAT - PIATTA
1	1385813	58,4 mm	S/STEEL	FLAT - PIATTA
2	1385815	53 mm	ANTICORODAL	FLAT - PIATTA
2	1385814	58 mm	ANTICORODAL	FLAT - PIATTA



1385803



1385804



1385805



1385806

LF Code	ø	Material
1385803	M10	ANTICORODAL
1385804	M10	ANTICORODAL
1385805	M10	ANTICORODAL
1385806	M10	ANTICORODAL



1385801



1385802



1385807



1385808

LF Code	ø	Material
1385801	M10	WOOD - LEGNO
1385802	M10	WOOD - LEGNO
1385807	M10	WOOD - LEGNO
1385808	M10	WOOD - LEGNO

-  Pressini
-  Tamper for coffee
-  Tamper - Kaffeepresser
-  Prensa café



La pressatura del caffè espresso è una delle vere chiavi della sua qualità. Il pressino dinamometrico è lo strumento che permette di pressare il caffè sempre con la giusta forza.

**Principali vantaggi:**

- Pressione costante, omogenea e uniforme del caffè macinato indipendentemente dal variare degli operatori, delle loro diverse abitudini e dalla variazione di fattori esterni (clima, orario, ecc.)
- Uniformità della superficie del caffè macinato
- Limitazione degli interventi sulla macinatura del caffè a quelli strettamente indispensabili legati, ad esempio, a variazioni climatiche di temperatura e umidità
- Elevata costanza della qualità del caffè espresso



Der richtige Anpressdruck ist ein Schlüsselfaktor für guten Kaffee. Der dynamometrische Kaffeepresser übt immer den exakt gleichen Druck aus.

**Die wichtigsten Vorteile:**

- Immer gleicher Anpressdruck bei jedem Anwender, auch bei unterschiedlicher Handhabung oder anderen externen Faktoren (Wetterbedingungen, Zeit, etc.)
- Gleichmässige Oberfläche des Kaffeepulvers
- Reduziert die Einwirkungen auf das Kaffeepulver von außen, wie zum Beispiel durch Luftfeuchtigkeit und Temperatur
- Konstante Kaffeequalität



The correct press of coffee is a key quality factor. The dynamometric tamper enables you to press coffee exactly anytime.

**Main advantages:**

- Constant and even pressure of the ground coffee regardless of the operators, their different habits and external factors (weather conditions, time, etc.)
- Even top of the ground coffee
- Few interventions on the coffee grinder, for instance, to setting of temperature and humidity
- Constant espresso coffee quality



El prensador del café espresso es una de las verdaderas claves de su calidad. El prensador dinamométrico es el instrumento que permite prensar el café siempre con la justa fuerza.

**Principales ventajas:**

- Presión constante, homogénea y uniforme del café molido independientemente del cambio de los operadores, de sus diversas costumbres y de la variación de factores externos (clima, horario, etc.)
- Uniformidad de la superficie del café molido
- Limitación de las intervenciones sobre la molienda del café en aquellas estrechamente e indispensables uniones como ejemplo una variación de temperatura y humedad
- Elevada constancia de la calidad del café espresso



1385082



1385083







1385084



1385085

LF Code	ø	Material	Pressing zone	Pressure (Kg)
1385082	53 mm	ALUMINIUM - S. STEEL	FLAT - PIATTA	15/21
1385083	54 mm	ALUMINIUM - S. STEEL	FLAT - PIATTA	15/21
1385084	57 mm	ALUMINIUM - S. STEEL	FLAT - PIATTA	15/21
1385085	58 mm	ALUMINIUM - S. STEEL	FLAT - PIATTA	15/21

-  Pressini
-  Tamper for coffee
-  Tamper - Kaffeepresser
-  Prensas café



1385600



1385601



1385602



1385605



1385606

LF Code	∅	Material	Pressing zone	Pressure (Kg)
1385600	57 mm	ALUMINIUM - ALLUMINIO	FLAT - PIATTA	14
1385601	52 mm	ALUMINIUM - ALLUMINIO	FLAT - PIATTA	14
1385602	57 mm	PLASTIC - PLASTICA	FLAT - PIATTA	---
1385605	52-57 mm	ALUMINIUM - ALLUMINIO	FLAT - PIATTA	25
1385606	57 mm	ALUMINIUM - ALLUMINIO	FLAT - PIATTA	25

-  Pressini
-  Tamper for coffee
-  Tamper - Kaffeepresser
-  Prensas café



1385002



1385000



LF Code	ø	Material	Pressing zone
1385002	50-57 mm	NYLON	FLAT - PIATTA
1385000	50-52 mm	NYLON	FLAT - PIATTA



1385350







1385351



LF Code	Description
1385350	FILTER HOLDER - SUPPORTO PORTAFILTRO
1385351	FILTER HOLDER - SUPPORTO PORTAFILTRO



-  Pressini
-  Tamper for coffee
-  Tamper - Kaffeepresser
-  Prensas café



1385734



1385778



1385779



1385775



1385780



1385781

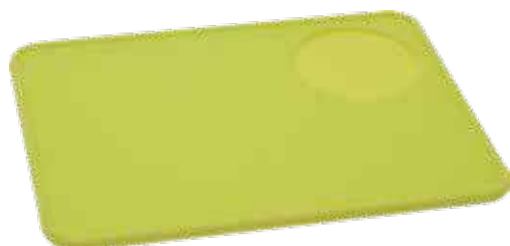

1385782



1385783

LF Code	Description	Dimensions	Material
1385734	BLACK MAT - TAPPETINO APPOGGIO NERO	238x160x48 mm	SILICON RUBBER - GOMMA SILICONICA
1385778	BLACK MAT - TAPPETINO APPOGGIO NERO	200x150x45 mm	SILICON RUBBER - GOMMA SILICONICA
1385779	BLACK MAT - TAPPETINO APPOGGIO NERO	170x140x37 mm	SILICON RUBBER - GOMMA SILICONICA
1385775	BLACK MAT - TAPPETINO APPOGGIO NERO	220x170 mm	SILICON RUBBER - GOMMA SILICONICA
1385780	PINK MAT - TAPPETINO APPOGGIO ROSA	200x150 mm	SILICON RUBBER - GOMMA SILICONICA
1385781	ORANGE MAT - TAPPETINO APPOGGIO ARANCIONE	200x150 mm	SILICON RUBBER - GOMMA SILICONICA
1385782	GREEN MAT - TAPPETINO APPOGGIO VERDE	200x150 mm	SILICON RUBBER - GOMMA SILICONICA
1385783	BLUE MAT - TAPPETINO APPOGGIO AZZURRO	200x150 mm	SILICON RUBBER - GOMMA SILICONICA



1384001



1384014



1384712



1384711



1384021



1384002

LF Code	Description
1384001	SHOWER CLEANING BRUSH - SPAZZOLINO PULISCIDOCCE
1384014	SHOWER CLEANING BRUSH - SPAZZOLINO PULISCIDOCCE
1384712	SHOWER CLEANING BRUSH BASIC - SPAZZOLINO BASIC
1384711	SHOWER CLEANING BRUSH EXCLUSIVE - SPAZZOLINO EXCLUSIVE
1384021	WOODEN SHOWER CLEANING BRUSH - SPAZZOLINO PULISCIDOCCE IN LEGNO
1384002	BRUSH FOR MAINTENANCE - SPAZZOLINA PER MANUTENZIONE



1384003



1384011







1384006



1384005



LF Code	Description
1384003	BLACK SHOWER CLEANING BRUSH - SPAZZOLINO NERO
1384011	RED SHOWER CLEANING BRUSH - SPAZZOLINO ROSSO
1384006	BRUSH KIT - KIT SPAZZOLE DI RICAMBIO
1384005	CLEANING BRUSH F/GRINDING BURRS - SPAZZOLA MACINE

-  Spazzolini
-  Brushes
-  Bürsten & Reinigungspinsel
-  Cepillos



1384023



1384009



1384713

concept-art



1384022



1384020



1384019

LF Code	Description
1384023	CLEANING BRUSH 50 mm - PENNELLO PER PULIZIA 50 mm
1384009	CLEANING BRUSH - PENNELLO PER PULIZIA SAECO/GAGGIA
1384713	CLEANING BRUSH - PENNELLO PER PULIZIA
1384022	WOODEN CLEANING BRUSH - PENNELLO PER PULIZIA IN LEGNO
1384020	WOODEN CLEANING BRUSH - PENNELLO PER PULIZIA IN LEGNO
1384019	WOODEN CLEANING BRUSH - PENNELLO PER PULIZIA IN LEGNO



1384701



1384010







1384004



3394247

LF Code	ø (mm)
1384701	3.5
1384010	7.5
1384004	6.0
3394247	---

-  Spazzolini
-  Brushes
-  Bürsten & Reinigungspinsel
-  Cepillos







1384710



1384708



LF Code	Description
1384710	SHOWER CLEANING BRUSH STEAM - SPAZZOLINO STEAM
1384708	PLASTIC BRUSH - SPAZZOLA IN PLASTICA

-  Strumenti di misura
-  Measuring tools
-  Messinstrumente
-  Instrumentos de medida



**1394200**

 **RIFRATTOMETRO ATAGO PAL-COFFEE BX/TDS**

Strumento professionale in grado di determinare se l'estrazione del caffè avviene in modo ottimale.

Misura la percentuale di sostanze solide dissolte in un liquido.

Disponibili app a pagamento per sfruttare al meglio le potenzialità dello strumento e archiviare le letture.

Scale:  
BRIX 0,00÷25,00% risoluzione 0,01%  
TDS 0,00÷22,00% risoluzione 0,01%

Compensazione automatica della temperatura.

Tempo di risposta 3 secondi.

Grado di protezione IP65.

Dimensioni 105x50x30 mm.

 **REFRACTOMETER ATAGO PAL-COFFEE BX/TDS**

Professional tool able to determine if coffee extraction occurs in an optimal manner.

It measures the percentage of solid substances melted in a liquid.

An APP is available to purchase to make the most of its potentials and archive the stored data.

Scales:  
BRIX 0.00÷25.00% resolution 0.01%  
TDS 0.00÷22.00% resolution 0.01%

Automatic temperature compensation.

Response time: 3 seconds.

Protection level IP65.

Dimensions 105x50x30 mm.

 **REFRAKTOMETR ATAGO PAL-COFFEE BX/TDS**

Das professionelle Messinstrument überprüft, ob die Extraktion des Kaffees optimal gewährleistet ist.

Es zeigt den Prozentsatz der Feststoffe, die in der Flüssigkeit gelöst sind.

Es wird dazu eine App zur Speicherung der Messwerte zur Verfügung gestellt, die kostenpflichtig zum Download steht.

Skala:  
Brix 0,00÷25,00% Resolution 0,01%  
TDS 0,00÷22,00% Resolution 0,01%

automatischer Temperatursgleich.

Meßzeit 3 Sek.

Schutzkategorie IP65.

Maße 105x50x30 mm.

 **REFRACTÓMETRO ATAGO PAL-COFFEE BX/TDS**

Instrumento profesional que permite determinar si el grado de extracción del café es óptimo.

mediando el porcentaje de sustancias solidas disueltas en un líquido.

Disponible aplicación de pago para poder disfrutar del mejor potencial del instrumento y archivar las lecturas.

Escalas:  
BRIX 0,00÷25,00% resolución 0,01%  
TDS 0,00÷22,00% resolución 0,01%





Compensación automática de la temperatura.

Tiempo de respuesta de 3 segundos.

Grados de protección IP65.

Dimensiones 105X50X30 mm.



-  Strumenti di misura
-  Measuring tools
-  Messinstrumente
-  Instrumentos de medida



## 2102161

 **TEMPORIZZATORE DIGITALE 99'E 59" BIANCO**

funzionamento a batteria  
conto alla rovescia - cronometro  
memorizzazione del tempo impostato  
avviso acustico - clip tascabile  
supporto da tavolo - calamita

 **DIGITAL TIMER 99' AND 59" WHITE**

battery powered  
countdown - stopwatch  
memory of set up time  
acoustic alert - pocket clip  
table support - magnet

 **DIGITALZEITSCHALTER 99' UND 59" WEISS**

Batteriebetrieben  
Countdown - Stoppuhr  
Zeitzpeicherung  
Buzzer - Taschenklemme  
Tischhalterung - Magnet

 **TEMPORIZADOR DIGITAL 99' Y 59" BLANCO**

funcionamiento a batería  
cuenta atrás - cronómetro  
memoria de la hora establecida  
timbre acústico - clip de bolsillo  
soporte de mesa - imán



## 1446006

 **TEMPORIZZATORE DIGITALE 99' E 59"**

funzionamento a batteria  
conto alla rovescia  
cronometro  
avviso acustico  
calamita

 **DIGITAL TIMER 99' AND 59"**

battery operation  
count down  
chronometer  
buzzer  
magnet

 **DIGITALZEITSCHALTER 99' UND 59"**

Batteriebetrieben  
Countdown  
Chronometer  
Buzzer  
Magnet

 **TEMPORIZADOR DIGITAL 99' Y 59"**

funcionamiento con batería  
temporizador de cuenta atrás  
cronómetro  
aviso sonoro  
imán



1394553





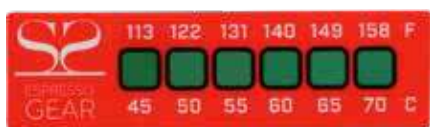

1394554



1394004

LF Code	Notes	Features
1394554	ANALOG THERMOMETER - TERMOMETRO	0+100°C - ø 45 mm
1394553	ANALOG THERMOMETER - TERMOMETRO	0+100°C - ø 25 mm
1394004	ADHESIVE THERMOMETER - TERMOMETRO ADESIVO	45+70°C

-  Tazzine e bicchieri
-  Cups and glasses
-  Kaffeetassen Gläser & Zubehör
-  Tazas y vasos

**Walküre**  
 PORZELLANFABRIK  
 MADE IN GERMANY



1880008



**TAZZINA CAFFÈ PER ASSAGGIO**  
 in porcellana  
 180 ml



**KAFFEE-VERKOSTUNG TASSE**  
 aus Porzellan  
 180 ml



**CUPPING BOWL**  
 porcelain  
 180 ml



**TAZA DE CATA PARA CAFÉ**  
 de porcelana  
 180 ml



1880101



1881003



1394706

LF Code	Stainless steel spoon (mm)
1880101	---
1881003	205
1394706	210



1880021



1880022



1881001



1394704

**Alta serie**

The right cup for any coffee

LF Code	Stainless steel spoon (mm)
1880021	---
1880022	---
1881001	110
1394704	108



1880023



1880027



1881002



1394705

**Alta serie**

The right cup for any coffee

LF Code	Stainless steel spoon (mm)
1880023	---
1880027	---
1881002	125
1394705	140





1880001



1880002



1880003



1881001



1394704

**Rossi serie**

Just the perfect cup

LF Code	Stainless steel spoon (mm)
1880001	---
1880002	---
1880003	---
1881001	110
1394704	108



1880004



1880007



1880005



1880006



1881002



1394705

**Rossi serie**

Just the perfect cup

LF Code	Stainless steel spoon (mm)
1880004	---
1880007	---
1880005	---
1880006	---
1881002	125
1394705	140

-  Utensili
-  Tools
-  Werkzeuge & Arbeitsgeräte
-  Herramientas



## 1394001

 **CHIAVE UNIVERSALE**

per tubi vapore e gruppi toglifiltro e guarnizioni sottocoppa chiave 8/11/12/13 mm apribottiglie

 **UNIVERSAL WRENCH**

for all steam pipes and coffee groups extractor for filter and filter holder gaskets wrench 8/11/12/13 mm bottle opener

 **UNIVERSALWERKZEUG**

für Dampfrohre und Kaffeegruppen Auszieher für Filter und Siebträgerdichtungen Schlüssel 8/11/12/13 mm Flaschenöffner

 **LLAVE UNIVERSAL**

para tubos vapor y grupos quitafiltro y juntas llave 8/11/12/13 mm abrebotellas



## 3394392

 **SPECCHIETTO DA ISPEZIONE CON LUCE LED**

3 led con pulsante ON/OFF Manico estensibile fino a 53 cm con estremità magnetica per innesto specchietto(ø 3,81 cm)

 **INSPECTION MIRROR WITH LED LIGHT**

3 leds with ON/OFF switch Extendable handle up to 53 cm with magnetic end for mirror connection (ø 3.81 cm)

 **INSPEKTIONSSPIEGEL MIT LED-LICHT**

3 Leds mit Druckschalter ON/OFF Ausdehnbarer Griff bis 53 cm mit Endstück magnetisch für Spiegelkupplung(ø 3,81 cm)

 **ESPEJO P. INSPECCIÓN CON LUZ LED**

3 led con pulsador ON/OFF Mango extensible hasta 53 cm con extremidad magnética para injerto espejo (ø 3,81 cm)



## 1505002

 **LEVAFILTERO INOX**

Con foro

 **EXTRACTOR FOR FILTER S.STEEL**

With hole

 **SIEBAUSZIEHER EDELST.**

Mit loch

 **SACAFILTRO A.INOX**

Con agujero



## 1505001

 **SET 4 UNCINI IN BUSTA**

ideali per lo smontaggio e il montaggio di o-ring, anelli di tenuta, guarnizioni in genere situate in punti difficili

 **4 HOOKS IN ENVELOPE KIT**

suitable for assembly and disassembly of o-ring, seals, gaskets usually located in difficult points

 **SET 4 HAKEN IN TÜTE**

ideal für den Einbau und Ausbau von O-ring, Dichtungen, Diese Dichtungen befinden sich für gewöhnlich an schwer erreichbaren Stellen

 **JUEGO 4 GANCHOS EN ESTUCHE**

ideales para el desmontaje y el montaje de aros O aro de cierre, juntas generalmente situadas en puntos difíciles



## 3394906

 **KIT TELESCOPICO ø 30x165 mm**

lunghezza totale in estensione 485 mm

 **TELESCOPIC KIT ø 30x165 mm**

extension overall length 485 mm

 **TELESKOPISCHER SATZ ø 30x165 mm**

Gesamtlänge bei Streckung 485 mm

 **KIT TELESCÓPICO ø 30x165 mm**

longitud total en extensión 485 mm



# LF GROUP

One app for both **smartphones** and **tablets**

**NEW**

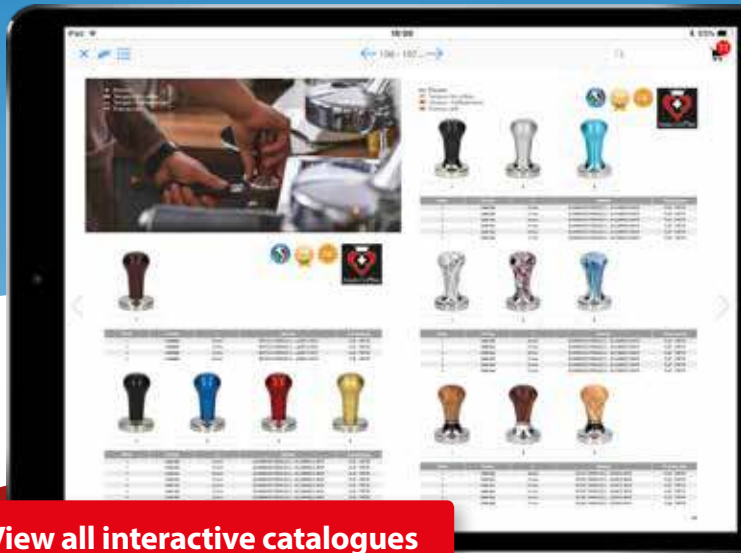

View all interactive catalogues



IOS, Android, tablet or smartphone  
LF Group is always with you



Download our **new** app today!

## FIND OUT THE NEW FEATURES



### NEW INTERFACE

Completely revamped and easy to use. Stay updated on all LF news



### FILTERS

Filter items by machine model, brand, sector and product family



### 360° PICTURE

Discover more than 20,000 items down to the smallest detail



### EXPLODED DRAWINGS

More than 200,000 exploded drawings at any time at your disposal



### CATALOGUES

The whole LF sales program in an instant



### BARCODE

Easily find an item using its barcode



## Distributing Components, Spare Parts & Accessories in original quality worldwide

---



### **LF SpA HEADQUARTERS**

via Voltri, 80 - 47522 Cesena (FC) ITALY  
Tel. +39 0547 34 11 11 - Fax +39 0547 34 11 10  
[www.lfircambi724.it](http://www.lfircambi724.it) - [info@lfircambi.it](mailto:info@lfircambi.it)  
Export Dept. Tel. +39 0547 34 11 50 - Fax +39 0547 34 11 55  
[www.lf Spareparts724.com](http://www.lf Spareparts724.com) - [export@lf Spareparts724.com](mailto:export@lf Spareparts724.com)



### **EPGC Sas FRANCE**

13, Rue des Forts - 59960 Neuville en Ferrain  
Tel. +33 (0)3 20 25 06 21 - Fax +33 (0)3 20 25 34 12  
[www.epgc.com](http://www.epgc.com) - [epgc@epgc.com](mailto:epgc@epgc.com)



### **LF GmbH GERMANY**

Junkersstrasse, 3 - D-82178 Puchheim - München  
Tel. +49 89 89 45 78 66 - Fax +49 89 89 45 78 88  
[www.lfersatzteile724.de](http://www.lfersatzteile724.de) - [info@lfersatzteile.de](mailto:info@lfersatzteile.de)



### **OOO LF RUSSIAN FEDERATION**

Ul. Anatoliya Zhivova, 8 - office 1 - 123100 Moscow  
Tel./Fax +7 495 725 26 53  
[www.lf Spareparts724.ru](http://www.lf Spareparts724.ru) - [info@lf Spareparts724.ru](mailto:info@lf Spareparts724.ru)



### **LF Repuestos Horeca S.L.U. SPAIN**

Poligono Industrial Carpetania - C/Miguel Faraday, 8 - 28906 Getafe  
Tel. +34 91 477 91 00 - Fax +34 91 477 90 81  
[www.lfrepuestos-horeca724.es](http://www.lfrepuestos-horeca724.es) - [info@lfrepuestos.es](mailto:info@lfrepuestos.es)



### **LF Scandinavia Aps - LF Spareparts S.p.A. DENMARK**

Nupark, 51 - 7500 Holstebro  
Tel. +45 70 70 77 33  
[www.lf Spareparts724.dk](http://www.lf Spareparts724.dk) - [denmark@lf Spareparts724.dk](mailto:denmark@lf Spareparts724.dk)



### **AUSTRALIA AND NEW ZEALAND**

[www.lf Spareparts724.com](http://www.lf Spareparts724.com)  
[andrea.calvio@lf Spareparts724.com](mailto:andrea.calvio@lf Spareparts724.com)



### **AUSTRIA**

[www.lfersatzteile724.at](http://www.lfersatzteile724.at)  
[info@lfersatzteile.at](mailto:info@lfersatzteile.at)



### **BALKAN COUNTRIES**

[www.lf Spareparts724.com](http://www.lf Spareparts724.com)  
[matija.ramov@lf Spareparts724.com](mailto:matija.ramov@lf Spareparts724.com)



### **BALTIC COUNTRIES**

[www.lf Spareparts724.com](http://www.lf Spareparts724.com)  
[inara.silina@lf Spareparts724.com](mailto:inara.silina@lf Spareparts724.com)



### **LF SpA Cesena (IT) Swiss Branch Steinhausen SWITZERLAND**

Sennweidstrasse, 45 - CH-6312 Steinhausen  
Tel. +41 (0)41 760 15 80/1 - Fax +41 (0)41 760 15 85  
[www.lfersatzteile724.ch](http://www.lfersatzteile724.ch) - [info@lfersatzteile.ch](mailto:info@lfersatzteile.ch)



### **LF Spare Parts Ltd. UNITED KINGDOM**

A10a Lakeside Business Park, Broadway Lane  
South Cerney, Gloucestershire GL7 5XL  
Tel. +44 (0)1285 86 16 25 - Fax +44 (0)1285 86 39 49  
[www.lf Spareparts724.co.uk](http://www.lf Spareparts724.co.uk) - [info@lf Spareparts724.co.uk](mailto:info@lf Spareparts724.co.uk)



### **LF Central Est Europe S.r.o. CZECH REPUBLIC**

Antala Staska 1859/34  
14000 Praha 4 - KRC  
Tel. +420 234 129 707  
[www.lf Spareparts724.cz](http://www.lf Spareparts724.cz) - [info@lf Spareparts724.cz](mailto:info@lf Spareparts724.cz)



### **LF SPARE PARTS INC. USA**

**Legal address:**  
155 Office Plaza Dr - Suite A - Tallahassee, FL 32301  
**Business/Mailing address:**  
1100 South Tower, 225 Peachtree St., N.E. - Atlanta, GA 30303, USA  
Tel. +1-404-525-2600 - Fax +1-404-586-3528  
[www.lf Spareparts724.us](http://www.lf Spareparts724.us) - [info@lf Spareparts724.us](mailto:info@lf Spareparts724.us)  
Tel. West Coast and Midwest: 206-349-1525 Sauro  
Tel. East Coast and the Caribbean: 786-817-1764 Luis



### **LATIN AMERICA AND THE CARRIBEANS**

[www.lfrepuestos-horeca724.es](http://www.lfrepuestos-horeca724.es)  
[export@lfrepuestos.es](mailto:export@lfrepuestos.es)



### **POLAND**

[www.lf Spareparts724.pl](http://www.lf Spareparts724.pl)  
[info@lf Spareparts724.pl](mailto:info@lf Spareparts724.pl)



### **SOUTH KOREA**

[www.lf Spareparts724.com](http://www.lf Spareparts724.com)  
[fabio.doni@lf Spareparts724.com](mailto:fabio.doni@lf Spareparts724.com)



### **TURKEY**

[www.lfyedekparca724.com](http://www.lfyedekparca724.com)  
[export@lf Spareparts724.com](mailto:export@lf Spareparts724.com)